



# The WORKSHOP Catalogue

March - June 2025 All prices quoted include GST.

## AGGUD **NEW!**

### 100 mm Digital Protractor



**SUPER COMPACT!**

- Button function: Hold/Rev, Set zero, On/Off
- Beam with integrated magnets
- Locking screw

Resolution: 0.05°  
Accuracy: ±0.3°  
Length: 103 mm **\$139**  
PN: AC-824-004-11

---

### Large Screen Dualscale Digital Caliper



**NEW!** IP54 Ingress Rating  
• USB Rechargeable

Resolution: 0.01 mm  
Accuracy: ±0.03 mm

150 mm Caliper **\$139** PN: AC-106-006-11  
200 mm Caliper **\$199** PN: AC-106-008-11  
300 mm Caliper **\$279** PN: AC-106-012-11

## NICRON **NEW!**

### USB Rechargeable Utility Work Lamp



Brightness: 1000 Lm  
Intensity: 4000 Cd

- USB-A power bank functionality
- USB-C Charge Port
- Battery State Indicator
- Magnetic 360° swivel base with interlocking lamp hangers
- 1/4 UNC tripod mount

**\$89**  
PN: WL86

Primary Beam:	Ingress Rating	Battery Indicator	Charge Port	Magnetic Base	Tripod Mount
LOW (20Lm)	IPX4	10% 100%	USB TYPE C	U	1/4" - 20 UNC
MED (500Lm)					
HIGH (750Lm)					
MAX (1000Lm)					
Weight: 333g					

---

### Rechargeable Mini Focusable Flashlight



**NEW!** Brightness: 450 Lm  
Intensity: 4000 Cd

Spot Light: LOW (20Lm), MED (130Lm), HIGH (450Lm), STROBE: (450Lm)

Battery: 750 Li-ion  
Ingress Rating: IPX4  
Charge Port: USB TYPE C  
Size: 153 x 18.4 mm  
Weight: 64g

**\$59**  
PN: F72R

**Full range on page 28.**

## geiger **NEW!**

### Metric Course Drill & Tap Kits

Kits include HSS Drill and HSS intermediate tap.

M4 x 0.7 PN: GDTKM4	<b>\$7</b>
M5 x 0.8 PN: GDTKM5	<b>\$8</b>
M6 x 1.0 PN: GDTKM6	<b>\$9</b>
M8 x 1.25 PN: GDTKM8	<b>\$14</b>
M10 x 1.5 PN: GDTKM10	<b>\$16</b>
M12 x 1.75 PN: GDTKM12	<b>\$24</b>

**More on page 3!**

## geiger **HOT PRICES!**

### Impact Socket Sets

1/2" Drive Metric or Imperial Socket Sets

was \$169 **Now! \$99**

**More on page 43!**

## Ezi-Shear **NEW!**

### Metal Cutting Shears

Trade quality shears that delivers outstanding service life and years of economical operation.

**CUTS LIKE A HOT KNIFE THROUGH BUTTER!**

**Full Range on page 39!**



## geiger

### Height Adjustable Hydraulic Stool



- 4" swivel wheels (2 lockable)
- Strong double walled seat
- Steel Frame

Height Range: 450-560 mm  
Max. Load: 150 Kg

**\$239**  
PN: GAHS

**More on page 19!**

## Thread Repair Kit

- Includes 1.5D long Stainless Steel threaded inserts
- HSS tap and twist drill

Replacement Thread Inserts on page 8.



**NEW SIZES!**

M6 x 1.0 Metric Course  
Includes 25 inserts  
PN: GTRKM6

**\$29**

M8 x 1.0 Metric Fine  
Includes 25 inserts  
PN: GTRKM8F

**\$34**

M8 x 1.25 Metric Course  
Includes 25 inserts  
PN: GTRKM8

**\$34**

M10 x 1.0 Metric Extra Fine  
Includes 25 inserts  
PN: GTRKM10EF

**\$29**

M10 x 1.25 Metric Fine  
Includes 25 inserts  
PN: GTRKM10F

**\$29**

M10 x 1.5 Metric Course  
Includes 25 inserts  
PN: GTRKM10

**\$39**

M12 x 1.25 Metric Extra Fine  
Includes 10 inserts  
PN: GTRKM12EF

**\$42**

M12 x 1.5 Metric Fine  
Includes 10 inserts  
PN: GTRKM12F

**\$42**

M12 x 1.75 Metric Course  
Includes 10 inserts  
PN: GTRKM12

**\$42**

M14 x 1.5 Metric Fine  
Includes 10 inserts  
PN: GTRKM14F

**\$45**

M14 x 2.0 Metric Course  
Includes 10 inserts  
PN: GTRKM14

**\$45**

## 3 Piece Step Drill Set

- TiN coated HSS
- Helical flute

Includes:  
4-12 MM,  
4-20 MM  
4-32 MM



**\$189**  
PN: G3SD

## Centre Drill Set

5 Piece set includes sizes:

- 1# Dia: 3.15 MM / 1.16 MM
- 2# Dia: 4.7 MM / 2 MM
- 3# Dia: 6.3 MM / 2.95 MM
- 4# Dia: 4.9 MM / 3.2 MM
- 5# Dia: 11 MM / 4.85 MM



**\$29**  
PN: GCDS

## Rotary Jobber Drill Stand



Range: 1-13 mm  
Capacity: 100 drill bits  
Size: 174 x 90 mm

**\$49**  
PN: VMS3

## Screw Extractor Set



5 piece set is suitable for extracting screws or bolts from 4M to M20.

**\$20**  
PN: GSES

## Soluble Cutting Oil

Contains emulsifiers and bactericides specifically formulated to provide excellent stability and rust prevention characteristics in hard water up to 400 ppm (expressed as calcium carbonate).

Mix between 5% to 10% with clean tap water.

1 Litre **\$34** 5 Litres **\$125** 20 Litres **\$419**  
PN: SOLOIL1 PN: SOLOIL5 PN: SOLOIL20



## Drill Tap & Countersink Bits

Drive: 1/4" Hex  
Sizes: M4 x 0.7, M5 x 0.8, M6 x 1.0, M8 x 1.25, M10 x 1.5  
Material: HSS M2  
Max. Workpiece Thickness: 5 mm

**CAN BE USED WITH IMPACT DRIVERS**

Drill  
Tap  
Deburr

5-Piece Set  
**\$59**  
PN: GDTDS5

M4 M5 M6 M8 M10

## Letter Stamp Sets

27 piece set includes A-Z plus "&" character  
Made from CRV (6150).



**NEW SIZES!**

10 mm Stamp Set  
PN: GYC601-10 **\$119**  
12 mm Stamp Set  
PN: GYC601-12 **\$149**  
16 mm Stamp Set  
PN: GYC601-16 **\$269**  
19 mm Stamp Set  
PN: GYC601-19 **\$309**

## Number Stamp Sets

9 piece set includes 0 to 8 (6 is used as 9)  
Made from CRV (6150).



**NEW SIZES!**

3 mm Stamp Set  
PN: GYC602-3 **\$30**  
4 mm Stamp Set  
PN: GYC602-4 **\$32**  
5 mm Stamp Set  
PN: GYC602-5 **\$39**  
6 mm Stamp Set  
PN: GYC602-6 **\$42**  
8 mm Stamp Set  
PN: GYC602-8 **\$52**  
10 mm Stamp Set  
PN: GYC602-10 **\$62**  
12 mm Stamp Set  
PN: GYC602-12 **\$89**  
16 mm Stamp Set  
PN: GYC602-16 **\$99**  
19 mm Stamp Set  
PN: GYC602-19 **\$129**

## Alphanumeric Stamp Sets

36 piece set includes 27 "A" to "Z", "&", and 9 Piece 0~8 (6 is used as 9)  
Hardness: HRC 58-62°



PN: GYC607-3 **\$60**  
4 mm Stamp Set  
PN: GYC607-4 **\$69**  
5 mm Stamp Set  
PN: GYC607-5 **\$86**  
6 mm Stamp Set  
PN: GYC607-6 **\$99**  
8 mm Stamp Set  
PN: GYC607-8 **\$179**

## Single Line Alphanumeric Stamp Sets

Made from S55C High carbon steel, HRC 58-60°.  
100 Piece set includes:  
9 Character Type Holder, hex wrench, A-Z, 0-9, &, /, - and blank space.

3 mm Stamp Set  
**\$499**  
PN: GYC610-3  
6 mm Stamp Set  
**\$609**  
PN: GYC610-6



## Drill Press Vices

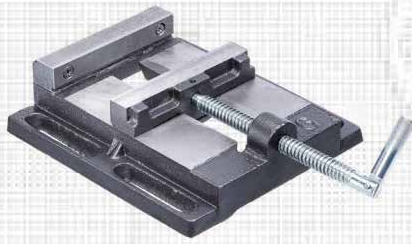

### 100 MM Drill Press Vice

Base: 177 x 161 mm  
Jaw Size: 101 x 23 mm  
Jaw opening: 100 mm

**\$52**

PN: TV102-4

### 150 MM Drill Press Vice

Base: 238 x 210 mm  
Jaw Size: 150 X 28 mm  
Jaw opening: 150 mm

**\$89**

PN: TV102-6

## Cross Vices

- Gibbed slide ways for slack adjustment
- Travel locks for repetitive work

### 100 MM Cross Vice

Base: 223 x 130 mm  
Overall height: 133 mm  
Jaw Size: 103 x 34 mm

**\$149**

PN: TV144-4

### 150 MM Cross Vice

Base: 280 x 160 mm  
Overall height: 160 mm  
Jaw Size: 154 x 44 mm

**\$249**

PN: TV144-6

## Round Vice

- Reversible mount for smaller bar diameters.
- Mount horizontally or vertically

Capacity: 10-80 mm round  
Base: 230 x 161 mm (Hor.)  
Base: 161 x 135 mm (Vert.)  
Jaw width: 100 mm



Colour may vary

**\$369**

PN: GVSR

## Metal Working Bench Vises

- Integrated anvil & pipe jaws
- Lockable 360° Swivel base

**HEAVY DUTY  
CAST STEEL!**



### 150 MM Bench Vice

Jaw face: 155 x 85 mm  
Jaw opening: 150 mm  
Weight: 14 kg

**\$379**

PN: GBV6

### 200 MM Bench Vice

Jaw face: 205 x 85 mm  
Jaw opening: 200 mm  
Weight: 18 kg

**\$489**

PN: GBV8

## Magnetic Soft Jaws

- Horizontal & vertical vee grooves
- Integrated magnets firmly hold soft jaws in position.



Vise not included.

100 MM

125 MM

150 MM

200 MM

**\$19**

**\$20**

**\$22**

**\$29**

PN: GMSJ4

PN: GMSJ5

PN: GMSJ6

PN: GMSJ8

**geiger™**

**NEW!**

## Diamond Knurling Tool Holders



### 3-1 Diamond Knurling Tool Holder

Shank: 20 x 20 x 140 mm  
Knurling Pitches:  
Fine - 0.8 mm  
Medium - 1.2 mm  
Coarse - 1.8 mm

**\$129**

PN: H-11-285-001

### Diamond Knurling Tool Holder

Shank: 20 x 12.7 x 100 mm  
Knurling Pitch: 1 mm

**\$59**

PN: H-11-161-003

## Tungsten Steel Tap & Die Sets

### 39 Piece Metric / Imperial Tungsten Steel Tap & Die Set

**\$99**

PN: GTDS39

Set Includes: Long Handle & T-Handle Tap Wrench, Long Handle Die Wrench, Metric & Imperial Screw Pitch Gauge

Metric Tap & Dies:	Imperial Tap & Dies:
M3 x 0.5	#4-40 UNC
M4 x 0.7	#6-32 UNC
M5 x 0.8	#8-32 UNC
M6 x 1.0	1/4"-20 UNC
M7 x 1.0	5/16"-18 UNC
M8 x 1.25	3/8"-16 UNC
M10 x 1.5	7/16"-14 UNC
M12 x 1.75	1/2"-13 UNC

NPT Tap & Dies: 1/8"-27 NPT



### 60 Piece Metric / Imperial Tungsten Steel Tap & Die Set

Set Includes:  
T-Handle Tap Wrench,  
Long Handle Tap Wrench,  
Long Handle Die Wrench,  
Metric Screw Pitch Gauge,  
Imperial Screw Pitch Gauge

**\$149**

PN: GTDS60

Metric Tap & Dies:	Imperial Tap & Dies:
M3 x 0.5	M8 x 1.25
M4 x 0.7	M9 x 1.25
M5 x 0.8	M10 x 1.0
M6 x 1.0	M10 x 1.5
M7 x 1.0	M12 x 1.75

NPT Tap & Dies: 1/8"-27 NPT

#4-40 UNC	1/4"-28 UNF	7/16"-20 UNF
#6-32 UNC	1/4"-20 UNC	7/16"-14 UNC
#8-32 UNC	5/16"-24 UNF	1/2"-20 UNF
#10-32 UNF	5/16"-18 UNC	1/2"-13 UNC
#10-24 UNC	3/8"-24 UNF	
#12-24 UNC	3/8"-16 UNC	



## Metric Ti-N Coated Tungsten Steel Tap & Die Set

Set Includes Tap & Die Wrenches and the following fine & course metric tap & dies:

M6 x 0.75	M6 x 1.0
M8 x 1.0	M8 x 1.25
M10 x 1.25	M10 x 1.5
M12 x 1.5	M12 x 1.75
M14 x 1.5	M14 x 2.0
M16 x 1.5	M16 x 2.0
M18 x 1.5	M18 x 2.5
M20 x 1.5	M20 x 2.5
M22 x 1.5	M22 x 2.5
M24 x 1.5	M24 x 3.0

**\$229**

PN: GTDS45



**Haaga 375**  
Commercial Sweeper

Performance: 2,900 m<sup>2</sup>/h  
Cleaning Width: 750 mm  
Capacity: 50 Liters  
Weight: 11.1 kg

**\$1175**  
PN: HG375



**Haaga 477**  
Commercial Sweeper

- Stores vertically in most closets (1550H x 780W x 300 MM)

Performance: 3,000 m<sup>2</sup>/h  
Cleaning Width: 770 mm  
Capacity: 50 Liters  
Weight: 15 kg

**\$1559**  
PN: HG477

**FITS IN MOST CLOSETS**



**Haaga 497**  
Commercial Sweeper

Performance: 3,600 m<sup>2</sup>/hr  
Cleaning Width: 970 mm  
Capacity 50 litres.  
Weight: 15.7 Kg

**\$1919**  
PN: HG497



**Porta**



**13 MM Keyless Drill Chuck**

High quality metal chuck to suit most Milwaukee M18™ 13 MM Drills & Drivers

Capacity: 1.5-13 mm  
Mount: 9/16 x 18 TPI

**\$95**

PN: PORTSS13F916R



**13 MM Keyed Drill Chucks**

Capacity: 1.5-13 mm  
Body Dia.: 43 mm  
Mount: JT6  
Chuck Key: KS2

**\$89**

PN: PORA13J6



**NEW!**

**16 MM Keyed Drill Chucks**

Capacity: 1-16 mm  
Outer diameter: 56 mm  
Mount: JT6  
Key Type: T7

**\$129**

PN: PORAP16J6



**13 MM Keyless Drill Chucks**

Capacity: 1.5-13 mm  
Mount: 1/2" x 20

**\$139**

PN: PORTS13F12R

**20 MM Keyed Drill Chucks**

Capacity: 5-20 mm  
Outer diameter: 64 mm  
Key Type: PORKS4B

**\$189**

PN: PORAP20J3

**Keyless Drill Chucks**

- Suitable for lathes, drilling & milling machines

Capacity: 1-13 mm  
Mount: JT6

**\$155**

PN: POR37J6



Capacity: 3-16 mm  
Mount: JT6

**\$175**

PN: POR40J6

**Ejecting Drift**

- Hardened and Black Oxide finish.



MT1/MT2 PN: PORDR12 **\$22**  
MT2/MT3 PN: PORDR23 **\$22**  
MT3/MT4 PN: PORDR34 **\$25**  
MT4/MT5 PN: PORDR45 **\$34**

**THE BONE™**  
CREEPERS & STOOLS



**THE BONESTER**  
SUPER LOW PROFILE

1092L x 594W x 114H mm  
Wheels: Ø75 mm x 22 mm  
38 mm Ground Clearance  
Weight: 6 Kg



**180 KG CAPACITY**

**\$479**

PN: BONE4031

**VERTEX®** Drill Tooling

**Precision Keyless Chucks**

Especially suited to CNC machining centre and milling machine use.

**Keyless 13 MM / JT6 Drill Chuck**

Accuracy: 0.05 / 50 mm  
Length: 105.3 mm (closed)

**\$199**

PN: VKD102



**Keyless 3-16 MM Drill Chuck**

Accuracy: 0.05 / 50 mm  
Length: 110.3 mm (closed)

**\$209**

PN: VKD104

**Drill Chuck Arbors**



Other sizes available.

MT2 x JT6 Arbor  
PN: DCAMT2J6

**\$29**

MT3 x JT6 Arbor  
PN: DCAMT3J6

**\$29**

**Drift Slide Hammer**

- Made from carbon steel

Length: 375 mm  
Weight: 1.3 Kg  
HRC: 44-48°



**\$99**

PN: VHD1



Established in the early 1980s in Lodi, Italy, HARLINGEN has evolved into a global powerhouse in the engineering sector, specialising in CNC tooling for the aerospace, automotive and manufacturing industries. Today, HARLINGEN has expanded their range and with strategic fulfillment centres in California and Shanghai. They proudly cater to thousands of clients operating in over 40 countries worldwide.

## Coated Micro-Grain Carbide Turning Inserts

• Sold in packs of 10



PN	Shape	Point Radius	Cutting Width	Thickness	
TCMT16T304	Triangle	0.4 mm	16 mm	3.97 mm	<b>\$119</b>
TCMT16T308	Triangle	0.8 mm	16 mm	3.97 mm	<b>\$119</b>
TPMR160304	Triangle	0.4 mm	16 mm	3.18 mm	<b>\$119</b>
TPMR160308	Triangle	0.8 mm	16 mm	3.18 mm	<b>\$119</b>
TNMG160404	Triangle	0.4 mm	16 mm	4.76 mm	<b>\$119</b>
TNMG160408	Triangle	0.8 mm	16 mm	4.76 mm	<b>\$119</b>
WCMT050308	Trigon	0.8 mm	5 mm	3.18 mm	<b>\$139</b>
WCMT06T304	Trigon	0.4 mm	6 mm	3.97 mm	<b>\$129</b>
WNMG080404	Trigon	0.4 mm	8 mm	4.76 mm	<b>\$139</b>
WNMG080408	Trigon	0.8 mm	8 mm	4.76 mm	<b>\$139</b>
DCMT070204	55° Rhomboid	0.4 mm	7 mm	2.38 mm	<b>\$129</b>
DCMT11T304	55° Rhomboid	0.4 mm	11 mm	3.97 mm	<b>\$149</b>
CCMT060204	80° Rhomboid	0.4 mm	6 mm	2.38 mm	<b>\$99</b>
CNMG120404	80° Rhomboid	0.4 mm	12 mm	4.76 mm	<b>\$139</b>
CNMG120408	80° Rhomboid	0.8 mm	12 mm	4.76 mm	<b>\$140</b>
CCMT09T304	80° Rhomboid	0.4 mm	9 mm	3.97 mm	<b>\$129</b>
CCMT120408	80° Rhomboid	0.8 mm	12 mm	4.76 mm	<b>\$149</b>

## TiAlN Micro-Grain Carbide Right Handed Threading Inserts

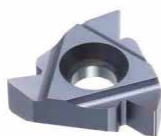

- Made of micro-grain carbide with TiAlN coating
- Suited to cast iron, general purpose steel and stainless steel
- Sold in packs of 10

Thread Profile	Thread Range	Insert Size	PN	
60° External	0.5 - 1.5 mm	IC 6.35 mm	11ERA60	<b>\$159</b>
60° External	0.5 - 3.0 mm	IC 9.525 mm	16ERAG60	<b>\$159</b>
55° Internal	0.5 - 3.0 mm	IC 9.525 mm	16IRAG55	<b>\$159</b>
60° Internal	0.5 - 3.0 mm	IC 9.525 mm	16IRAG60	<b>\$159</b>
55° External	48 - 16 TPI	IC 6.35 mm	11ERA55	<b>\$159</b>
55° External	48 - 8 TPI	IC 9.525 mm	16ERAG55	<b>\$159</b>

## Coated Micro-Grain Carbide Milling Inserts

• Sold in packs of 10

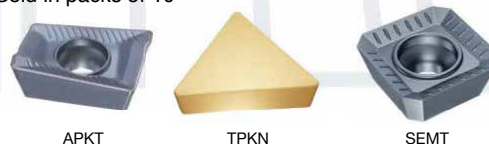

PN	Shape	Point Radius	Cutting Width	Thickness	
APKT1003	Parallelogram	0.4 mm	10 mm	3.53 mm	<b>\$119</b>
APKT160408	Parallelogram	0.8 mm	16 mm	5.3 mm	<b>\$139</b>
TPKN160308	Triangle	0.8 mm	16 mm	3.18 mm	<b>\$129</b>
SEMT1204	Square		12 mm	4.76 mm	<b>\$139</b>

## TiN Coated Carbide GTN Parting & Grooving Inserts

• Suited to general purpose steel

• Sold in packs of 10



Cutting Width	PN	
2 mm	GTN-2	<b>\$89</b>
3 mm	GTN-3	<b>\$89</b>
4 mm	GTN-4	<b>\$119</b>
5 mm	GTN-5	<b>\$139</b>

## TiAlN Micro-Grain Carbide MGMN Parting & Grooving Inserts

- Suited to general purpose steel and stainless steel
- Sold in packs of 10



Cutting Width	PN	
2 mm	MGMN200	<b>\$149</b>
3 mm	MGMN300	<b>\$159</b>

## Nickel Plated Cut-Off Tool Blades & Blocks

• Corrosion resistant Nickel Plating

### Parting Blades



Size	PN	
19 x 2 mm	NCIH19-2	<b>\$59</b>
19 x 3 mm	NCIH19-3	<b>\$59</b>
26 x 2 mm	NCIH26-2	<b>\$59</b>
26 x 3 mm	NCIH26-3	<b>\$59</b>
32 x 3 mm	NCIH32-3	<b>\$109</b>
32 x 4 mm	NCIH32-4	<b>\$109</b>
32 x 5 mm	NCIH32-5	<b>\$109</b>

### Parting Blocks

Length	Blade Width	Blade Height	Shank	PN	
56 mm	2-3 mm	19 mm	12 mm	SLTBN12-02	<b>\$89</b>
75 mm	2-3 mm	26 mm	16 mm	SLTBN16-05	<b>\$99</b>
75 mm	2-3 mm	26 mm	20 mm	SLTBN20-05	<b>\$99</b>
75 mm	2-5 mm	32 mm	25 mm	SLTBN25-06	<b>\$129</b>



## Nickel Plated 7 Piece Indexable Lathe Tool Sets

- Corrosion resistant Nickel Plating

Each set includes the following tool holders, inserts, torx and hex wrenches.

Left & Right Handed CCMT Tool Holders  
Neutral & Right Handed DCMT Tool Holders  
Right Handed WCMT Tool Holder  
Grooving Tool Holder & Threading Tool Holder



PN: H-11-126-T20

12 MM Shank

**\$299**

PN: H-11-126-T20

16 MM Shank

**\$339**

PN: H-11-126-T25

20 MM Shank

**\$399**

PN: H-11-126-T30

## Nickel Plated Threading Tool Holder Set

- Set includes tool holders and four ti-nite coated tungsten carbide inserts for right-handed metric fine and coarse, internal and external thread cutting
- Suited to general purpose steel cast iron, and stainless steel

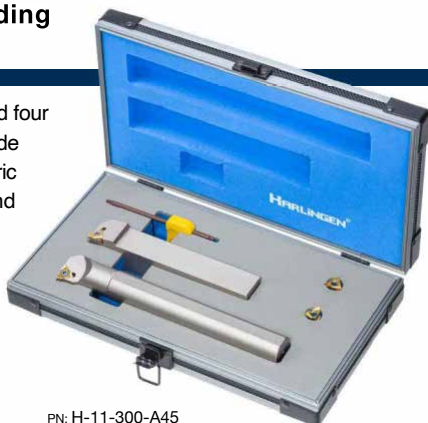

PN: H-11-300-A45

16 MM Shank

**\$249**

PN: H-11-300-A30

20 MM Shank

**\$289**

PN: H-11-300-A40

25 MM Shank

**\$329**

PN: H-11-300-A45

## Cut-Off & Grooving Lathe Tool Sets

- Corrosion resistant Nickel Plating

Kit includes the following ranges of tool block, blades and 10 inserts



PN: H-11-262-T30

Block	Blades	Parting Inserts	PN	
12 mm	19 x 2 & 3 mm	GTN-2, GTN-3	H-11-262-T15	<b>\$269</b>
16 mm	26 x 2 & 3 mm	GTN-2, GTN-3	H-11-262-T20	<b>\$299</b>
20 mm	26 x 2 & 3 mm	GTN-2, GTN-3	H-11-262-T30	<b>\$319</b>
25 mm	32 x 3, 4 & 5 mm	GTN-3, GTN-4, GTN-5	H-11-262-T35	<b>\$489</b>

## Nickel Plated CCMT Boring Bar Set

- Set includes boring bars with TiN Micro-Grain Carbide Semi-Finishing CCMT Inserts
- Suited to cast iron, general purpose steel and stainless steel

4 Piece set includes:  
8 x 100mm Boring Bar  
10 x 125mm Boring Bar  
12 x 150mm Boring Bar  
16 x 200mm Boring Bar



**\$279**

PN: H-11-383-T19

## 90° APKT Indexable End Mill Set

- Set includes an APKT tool holder and 20 TiAlN micro-grain carbide inserts
- Suited to semi-finishing of general purpose steel

Shank Dia: 16 mm  
Length: 85 mm  
Cutting Dia: 16 mm  
Inserts Pockets: 2

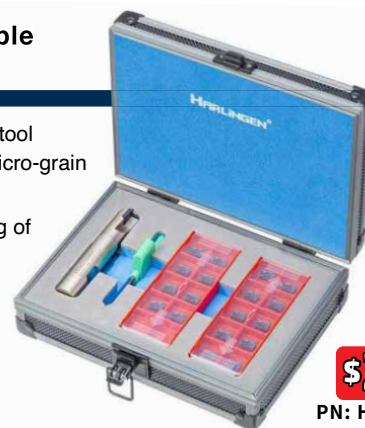

**\$289**

PN: H-11-373-S40

## 90° APKT Indexable Nickel Plated Carbide Face Mill Set

- This multi-purpose 90° milling cutter fitted with coated micro-grain APKT inserts allows high depth of cut and feed per tooth.
- Suitable for square shoulder face and side milling of steel, steel alloys, heat resistant steel, stainless steel and as well as cast iron.

Diameter: 50 mm  
Height: 40 mm  
Hole diameter: 22 mm  
Keyway Width: 10.4 mm

Set 21 Piece set includes:  
1 x 50 mm Milling cutter  
20 x TiAlN APKT carbide inserts



**NEW!**

**\$389**

PN: H-11-374-S40

## 90° APKT Indexable Carbide Face Mills

- High precision and high stock removal rates.
- Swiss SFS high strength insert screws.
- High grade alloy steel (HRC45-HRC48).
- Suitable for light to medium square shoulder milling.
- Less than 0.02 mm radial and axial run-out.
- Suits APKT1604 Inserts.

Inserts not included.



**NEW!**

Diameter	Height	Shank dia.	Keyway Width	PN	
50 mm	40 mm	22 mm	10.4 mm	H-231-51-002	<b>\$149</b>
100 mm	50 mm	32 mm	14.4 mm	H-231-51-005	<b>\$259</b>

## 90° TCMT Indexable Countersink

- Cut 5 times faster than HSS tools
- Suited to semi-finishing of general purpose steel
- Includes 2 inserts

Size: 12 - 32.5 mm  
Shank: 25 mm  
Insert: 2 x TCMT16T304



**\$169**  
PN: H-11-132-T30

## Nickel Plated CCMT Boring Bars

- Corrosion resistant Nickel Plating



**NEW!**

Shank Size	Insert	PN
12 x 150 mm	CCMT0602**	S12M-SCLCR-06
16 x 200 mm	CCMT09T3**	S16R-SCLCR-09
20 x 250 mm	CCMT09T3**	S20S-SCLCR-09

**\$79**

**\$89**

**\$99**

## Welders Vises

- High quality cast iron body
- Copper plated spindle for spatter protection
- Quick-Release spindle



Jaw Face	Miter Capacity	PN
105 x 35 mm	85 mm	H-40-076-008
135 x 61.5 mm	120 mm	H-40-076-009

**\$129**

**\$169**

## Drill Press Vises

- Replaceable precision hardened & ground prisma jaws
- Rolled trapezoidal spindle thread
- High quality cast iron body



Jaw Face	Jaw Opening	Weight	PN
100 x 27 mm	75 mm	3.5 Kg	H-41-074-002
150 x 34 mm	125 mm	7.0 Kg	H-41-074-004
200 x 40 mm	175 mm	10.0 Kg	H-41-074-005

**\$99**

**\$169**

**\$289**

## 1-13mm HSS Stepped Head Drill Set

- Stepped head provides stability in thin materials
- Superior drilling speeds over standard drills

25 piece set includes drill bits from 1 to 13 mm in 0.5 mm increments

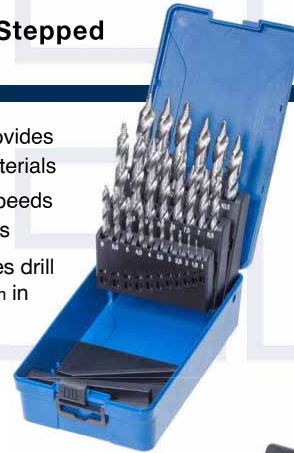

**\$249**

PN: H-512-96-8S2

## 1-13 mm HSS Drill Set

- 135° split point

25 piece set includes drill bits from 1 to 13 mm in 0.5 mm increments  
Material: HSS



**\$119**

PN: H-512-11-1S1

## 1-13 mm Cobalt/HSS Drill Set

- HSS, Cobalt 5% (M35)
- 135° split point

25 piece set includes drill bits from 1 to 13 mm in 0.5 mm increments.  
Material: HSS, Cobalt 5% (M35)



**\$179**

PN: H-512-11-4S1

## 170 Piece Cobalt/HSS Twist Drill Set

- HSS, Cobalt 5% (M35)
- 135° split point

170 piece set includes ten sets of:  
1.0 to 8.0 mm drill bits in 0.5 mm increments  
Five sets of 8.5 to 10.0 mm drill bits in 0.5 mm increments.



**\$479**

PN: H-11-275-003



## Extended T-Handle Tap Wrenches

Forward, Locked & Reverse Ratchet  
Slidable T-handle



Range	Length	PN
M3-M10	250 mm	H-11-104-005
M5-M13	235 mm	H-11-104-006

**\$39**

**\$39**

## Master Thread Repair Kits



## Adjustable Tap & Reamer Wrenches

Meets DIN1814 standards

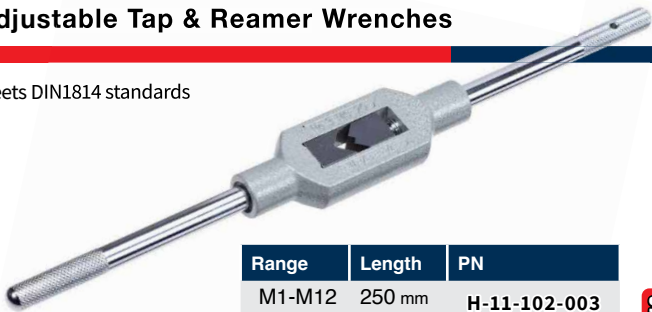

Range	Length	PN
M1-M12	250 mm	H-11-102-003
M5-M20	380 mm	H-11-102-005
M13-M32	700 mm	H-11-102-007

**\$19**

**\$39**

**\$109**

- The most reliable and effective tool for thread repair.
- Quickly and permanently restore stripped, worn or damaged threads to their original size, condition and strength.
- Increase the strength and durability of threads in soft materials.

### M5 to M12 Master Thread Repair Kit

Set includes: HSS STI taps & drill bits 1.5D Stainless steel wire inserts in the following sizes:  
25 x M5 x 0.8, 25 x M6 x 1.0  
25 x M8 x 1.25, 25 x M10 x 1.5  
10 x M12 x 1.75

**\$179**

PN: H-11-303-A01

## HSS Plug Tap & Twist Drill Set

15 piece set includes Tapping Wrench and the following drills and taps:  
M3 x 0.50 mm  
M4 x 0.70 mm  
M5 x 0.80 mm  
M6 x 1.00 mm  
M8 x 1.25 mm  
M10 x 1.50 mm  
M12 x 1.75 mm



**\$99**

PN: H-542-36-S01

### 1/4" to 1/2" UNC Master Thread Repair Kit

Set includes: HSS STI taps & drill bits 1.5D Stainless steel wire inserts in the following sizes:  
25 x 1/4"-20 UNC, 25 x 5/16"-18 UNC  
25 x 3/8"-16 UNC, 25 x 7/16"-14 UNC  
10 x 1/2"-13 UNC

**\$189**

PN: H-12-303-A01UNC

### 1/4" to 1/2" UNF Master Thread Repair Kit

Set includes: HSS STI taps & drill bits 1.5D Stainless steel wire inserts in the following sizes:  
25 x 1/4"-28 UNF, 25 x 5/16"-24 UNF  
25 x 3/8"-24 UNF, 25 x 7/16"-20 UNF  
10 x 1/2"-20 UNF

**\$189**

PN: H-12-303-A02UNF

## 90° HSS Three Flute Countersink Set

- Achieve consistent high quality results and chatterless burr-free operation with the latest unequally spaced geometry
- CBN ground deep flutes for significantly smoother & sharper cutting edges
- Suitable for metal, plastics & non-ferrous materials.

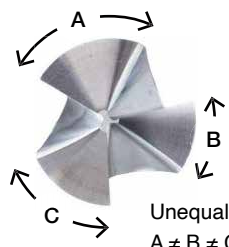

Unequally spaced flutes  
A ≠ B ≠ C



**\$119**

PN: H-11-040-S01

6 Piece set includes the following sizes: 6.3, 8.3, 10.4, 12.4, 16.5, 20.5 mm

## Stainless Steel Threaded 1.5D Inserts



Thread Profile	Thread Length	Quantity	PN	
M5 x 0.8	7.5 mm	25	H-11-303-310	<b>\$19</b>
M6 x 1.0	9 mm	25	H-11-303-315	<b>\$19</b>
M8 x 1.25	12 mm	25	H-11-303-320	<b>\$19</b>
M10 x 1.5	15 mm	25	H-11-303-325	<b>\$19</b>
M12 x 1.75	18 mm	10	H-11-303-330	<b>\$19</b>
1/4"-20 UNC	0.375"	25	H-12-303-310	<b>\$19</b>
5/16"-18 UNC	0.46875"	25	H-12-303-315	<b>\$19</b>
3/8"-16 UNC	0.5625"	25	H-12-303-320	<b>\$19</b>
7/16"-14 UNC	0.65625"	25	H-12-303-325	<b>\$29</b>
1/2"-13 UNC	0.75"	10	H-12-303-330	<b>\$19</b>
1/4"-28 UNF	0.375"	25	H-12-303-350	<b>\$19</b>
5/16"-24 UNF	0.46875"	25	H-12-303-355	<b>\$19</b>
3/8"-24 UNF	0.5625"	25	H-12-303-360	<b>\$19</b>
7/16"-20 UNF	0.65625"	25	H-12-303-365	<b>\$29</b>
1/2"-20 UNF	0.75"	10	H-12-303-370	<b>\$19</b>





## Precision Angle Lock Milling Machine Vises with Swivel Base

- Thrust ball bearing spindle for higher clamping forces
- Angle-lock designed to prevent jaw lift
- Vise body made of high grade cast iron
- Hardened and ground guide surfaces
- Replaceable hardened and ground clamping jaws
- Shielded spindle



Jaw Face	Jaw Opening	Weight	PN	
160 x 45 mm	160 mm	39 Kg	H-40-085-006	<b>\$469</b>
200 x 50 mm	235 mm	60 Kg	H-40-085-010	<b>\$899</b>

## 150 mm / 6" Tilting Machine Vise

- This machine vise features great rigidity & clamping force and has engraved quadrants on the tilt and swivel axes.



Jaw Face: 160 x 50 mm  
Jaw opening: 125 mm  
Weight: 39 Kg

**\$769**

PN: H-40-083-003

## Precision Angle Lock Milling Machine Vises

- Thrust ball bearing spindle for higher clamping forces
- Angle-lock designed to prevent jaw lift
- Vise body made of high grade cast iron
- Hardened and ground guide surfaces
- Replaceable hardened and ground clamping jaws
- Shielded spindle

Jaw Face: 152 x 45 mm  
Jaw opening: 230 mm  
Weight: 33 Kg



**\$989**

PN: H-40-085-007H

## 150 mm High Precision Modular Vise

- High precision accuracy to 0.01 mm
- Angle-lock designed to prevent jaw lift
- Made of high grade steel alloy
- Height matched

Jaw Face: 150 x 50 mm  
Jaw Opening: 200 mm  
Overall Length: 420 mm  
Hardness: HRC 58-62

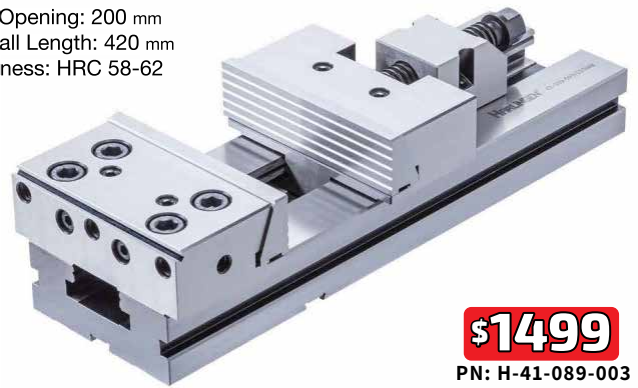

**\$1499**

PN: H-41-089-003

## Clamping Kits

- Kits manufactured from high quality quenched and tempered steel with black oxide finish

58 piece Kit includes 24 stud bolts (4 each in length), 75, 100, 125, 150, 175, 200 mm, 4 extension nuts, 6 stepped finger clamps (3 pairs), 6 T-slot nuts, 6 flange nuts, 3 pairs of stepped blocks



T-Slot	Stud	PN	
12 mm	M10	H-41-061-001	<b>\$169</b>
7/16"	3/8"	H-42-061-001	<b>\$179</b>
14 mm	M12	H-41-061-002	<b>\$189</b>
15.7 mm	M12	H-41-061-002-1	<b>\$189</b>
16 mm	M14	H-41-061-003	<b>\$199</b>
18 mm	M16	H-41-061-004	<b>\$329</b>
20 mm	M18	H-41-061-005	<b>\$579</b>



## 1/4" Shank Double-Cut Carbide Burrs

Standard & Non-ferrous 1/4" Shank Carbide Burrs are available in three head diameters.



**Stainless Carbide Burrs also available.**

### Oval Burrs

Size	Length	PN	Price
1	2"	CBSE1	<b>\$45</b>
3	2 3/8"	CBSE3	<b>\$66</b>
5	2 5/8"	CBSE5	<b>\$89</b>

### Radiused Tree Burrs

Size	Length	PN	Price
1	2"	CBSF1	<b>\$45</b>
3	2 1/2"	CBSF3	<b>\$66</b>
5	2 3/4"	CBSF5	<b>\$88</b>

### Pointed Tree Burrs

Size	Length	PN	Price
1	2"	CBSG1	<b>\$45</b>
3	2 1/2"	CBSG3	<b>\$66</b>
5	2 3/4"	CBSG5	<b>\$89</b>

### Cylinder Burrs

Size	Length	PN	Price
1	2"	CBSA1	<b>\$45</b>
3	2 1/2"	CBSA3	<b>\$66</b>
5	2 3/4"	CBSA5	<b>\$89</b>

### End Cut Cylinder Burrs

Size	Length	PN	Price
1	2"	CBSB1	<b>\$45</b>
3	2 1/2"	CBSB3	<b>\$66</b>
5	2 3/4"	CBSB5	<b>\$89</b>

### Radiused Cylinder Burrs

Size	Length	PN	Price
1	2"	CBSC1	<b>\$45</b>
3	2 1/2"	CBSC3	<b>\$66</b>
5	2 3/4"	CBSC5	<b>\$89</b>

### Ball Burrs

Size	Length	PN	Price
1	2"	CBSD1	<b>\$45</b>
3	2 1/8"	CBSD3	<b>\$66</b>
5	2 1/4"	CBSD5	<b>\$88</b>

### Flame Burrs

Size	Length	PN	Price
1	2 3/4"	CBSH1	<b>\$45</b>
3	2 1/2"	CBSH3	<b>\$66</b>
5	3"	CBSH5	<b>\$89</b>

### Radiused Cone Burrs

Size	Length	PN	Price
1	2"	CBSL1	<b>\$45</b>
3	3"	CBSL3	<b>\$66</b>
5	3"	CBSL4	<b>\$88</b>

### Cone Burrs

Size	Length	PN	Price
1	1 7/8"	CBSM1	<b>\$45</b>
3	2 1/2"	CBSM4	<b>\$66</b>
5	2 3/4"	CBSM5	<b>\$89</b>

### Inverted Cone Burrs

Size	Length	PN	Price
1	2"	CBSN1	<b>\$45</b>
3	2 1/8"	CBSN3	<b>\$66</b>
5	2 1/4"	CBSN5	<b>\$88</b>

### 60° Countersink Burrs

Size	Length	PN	Price
1	2"	CBSJ1	<b>\$45</b>
3	2 1/4"	CBSJ3	<b>\$66</b>
5	2 3/8"	CBSJ5	<b>\$88</b>

### 90° Countersink Burrs

Size	Length	PN	Price
1	2"	CBSK1	<b>\$45</b>
3	2 1/8"	CBSK3	<b>\$66</b>
5	2 1/8"	CBSK5	<b>\$88</b>

## 1/4" Extended Carbide Burrs

### 6" Extended Size 3 Double-Cut Burrs

Shape	PN	Price
Cylinder	CBSA3L6	<b>\$110</b>
End Cut Cylinder	CBSB3L6	<b>\$110</b>
Radiused Cylinder	CBSC3L6	<b>\$110</b>
Ball	CBSD3L6	<b>\$110</b>
Oval	CBSE3L6	<b>\$110</b>
Radiused Tree	CBSF3L6	<b>\$110</b>
Pointed Tree	CBSG3L6	<b>\$110</b>
Radiused Cone	CBSL3L6	<b>\$110</b>

### 6" Extended Size 3 Non-ferrous Burrs

Shape	PN	Price
Radiused Cylinder	CBSC3L6NF	<b>\$110</b>
Ball	CBSD3L6NF	<b>\$110</b>
Oval	CBSE3L6NF	<b>\$110</b>
Radiused Tree	CBSF3L6NF	<b>\$110</b>
Flame	CBSH3L6NF	<b>\$110</b>

## Carbide Burr Sets

### 1/8" Head Carbide Burr 10 Piece Set

Shank Dia: 1/8"



**\$205**

PN: CBSET10

### 3/8" Head Carbide Burr 3 Piece Set

Shank Dia: 1/4"



**\$165**

PN: CBSET3

### 1/4" & 3/8" Head Burr 8 Piece Set

Shank Dia: 1/4"



**\$339**

PN: CBSET8

### 1/2" Head Carbide Burr 5 Piece Set

Shank Dia: 1/4"



**\$365**

PN: CBSET5

### 3/8" Head Non-ferrous Burr 3 Piece Set

Shank Dia: 1/4"



**\$195**

PN: CBSET3NF

### 3/8" Head Stainless Burr 3 Piece Set

Shank Dia: 1/4"



**\$209**

PN: CBSET3INOX

# Bolt Removal Kits

The four step extraction kit that enables safe & clean removal of broken studs or screws in confined spaces.

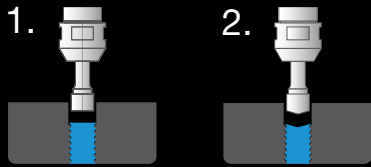

1. Flatten top of screw or stud

2. Form a countersink

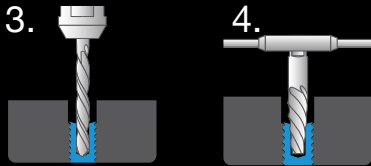

3. Drill into stud

4. Extract stud



Size	PN	Price
M6	CBSETBRM6	<b>\$105</b>
M8	CBSETBRM8	<b>\$115</b>
M10	CBSETBRM10	<b>\$129</b>
M12	CBSETBRM12	<b>\$139</b>
M14	CBSETBRM14	<b>\$175</b>

# morrisflex

## NG6 NEXT GENERATION ACCELERATOR



Patent pending geometry and **ACCELERATOR** Coating has shown up to double the rate of stock removal over conventional burrs.\*

### Cylinder Burrs

Size	Length	PN	Price
3	2 1/2"	CBSA3NG6C	<b>\$85</b>
5	2 3/4"	CBSA5NG6C	<b>\$115</b>

### Radiused Tree Burrs

Size	Length	PN	Price
3	2 1/2"	CBSF3NG6C	<b>\$85</b>
5	2 3/4"	CBSF5NG6C	<b>\$115</b>

### Radiused Cylinder Burrs

Size	Length	PN	Price
3	2 1/2"	CBSC3NG6C	<b>\$85</b>
5	2 3/4"	CBSC5NG6C	<b>\$115</b>

### Ball Burrs

Size	Length	PN	Price
3	2 1/8"	CBSD3NG6C	<b>\$85</b>

\* NG6 Coated Burrs should be operated at a minimum of 25,000 RPM.

## 1/4" Shank Non-ferrous Carbide Burrs

### Cylinder Burrs

Size	Length	PN	Price
1	2"	CBSA1NF	<b>\$67</b>
3	2 1/2"	CBSA3NF	<b>\$83</b>
5	2 3/4"	CBSA5NF	<b>\$105</b>

### Radiused Cylinder Burrs

Size	Length	PN	Price
1	2"	CBSC1NF	<b>\$66</b>
3	2 1/2"	CBSC3NF	<b>\$83</b>
5	2 3/4"	CBSC5NF	<b>\$105</b>

### Ball Burrs

Size	Length	PN	Price
1	2"	CBSD1NF	<b>\$66</b>
3	2 1/8"	CBSD3NF	<b>\$83</b>
5	2 1/4"	CBSD5NF	<b>\$105</b>

### Oval Burrs

Size	Length	PN	Price
1	2"	CBSE1NF	<b>\$66</b>
3	2 3/8"	CBSE3NF	<b>\$83</b>
5	2 5/8"	CBSE5NF	<b>\$105</b>

### Radiused Cone Burrs

Size	Length	PN	Price
1	2"	CBSL1NF	<b>\$66</b>
3	3"	CBSL3NF	<b>\$83</b>
5	3"	CBSL4NF	<b>\$105</b>

### Cone Burrs

Size	Length	PN	Price
3	2 1/2"	CBSM4NF	<b>\$105</b>

### Pointed Tree Burrs

Size	Length	PN	Price
1	2"	CBSG1NF	<b>\$66</b>
3	2 1/2"	CBSG3NF	<b>\$83</b>
5	2 3/4"	CBSG5NF	<b>\$105</b>

### Radiused Tree Burrs

Size	Length	PN	Price
1	2"	CBSF1NF	<b>\$66</b>
3	2 1/4"	CBSF3NF	<b>\$83</b>
5	2 3/8"	CBSF5NF	<b>\$105</b>

## 1/8" Carbide Burrs

1/8" Shank Carbide Burrs are available in the following head diameters:

**Size 00** 3/32" Head

**Size 0** 1/8" Head

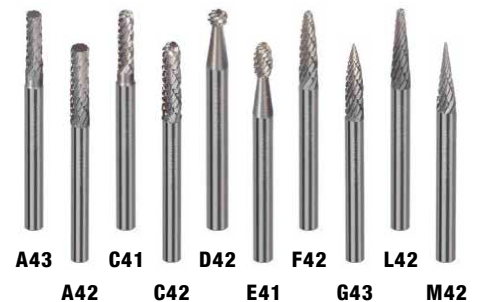

Shape	Size	PN	Price
Cylinder	0	CBSA43	<b>\$29</b>
Cylinder	00	CBSA42	<b>\$29</b>
Radiused Cylinder	0	CBSC41	<b>\$28</b>
Radiused Cylinder	00	CBSC42	<b>\$28</b>
Ball	0	CBSD42	<b>\$28</b>
Oval	0	CBSE41	<b>\$28</b>
Radiused Tree	0	CBSF42	<b>\$28</b>
Pointed Tree	0	CBSG43	<b>\$28</b>
Radiused Cone	0	CBSL42	<b>\$28</b>
Cone Burr	0	CBSM42	<b>\$28</b>

## Carbide Burr Operating Guide

These are recommended speeds for **Standard Length Burrs** with no more than a 1/2" overhang from the die-grinder collet. **NG6 Coated Burrs** should be operated at a minimum of 25K. **Extended Burrs** are generally subject to much lower maximum safe speeds.

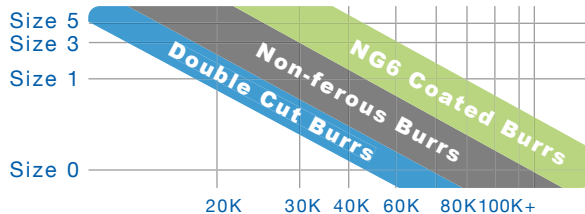



## 150 MM Digital Plastic Caliper



Resolution: 0.01 mm / 005"  
Accuracy:  $\pm 0.1$  mm

PN: AC-117-006-11  
**\$49**

## 70 MM Mini Vernier Caliper



Graduation: 0.05 mm  
Accuracy: 0.05 mm

PN: AC-121-003-11  
**\$89**

## Dual Scale Vernier Calipers

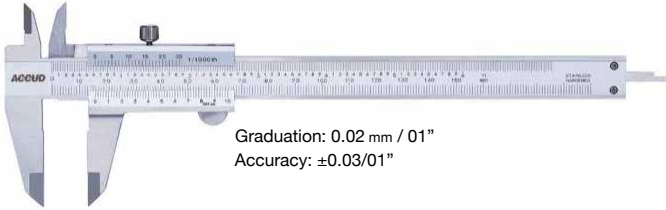

Graduation: 0.02 mm / 01"  
Accuracy:  $\pm 0.03/01$ "

150 mm Dual Scale Vernier Caliper

PN: AC-120-006-12  
**\$89**

200 mm Dual Scale Vernier Caliper

PN: AC-120-008-12  
**\$119**

300 mm Dual Scale Vernier Caliper

PN: AC-120-012-12  
**\$229**

## 125 MM Dual Scale Digital Disc Brake Caliper



- Measure disc brakes thickness
- Buttons: on/off, zero, mm/inch
- Automatic power on/off
- Made of stainless steel



Range: 0-125 mm/0-5"  
Resolution: 0.01 mm/0.0005"  
Accuracy:  $\pm 0.05$  mm  
Length: 223 mm

PN: AC-157-005-11  
**\$339**

## Dual Scale Digital Calipers

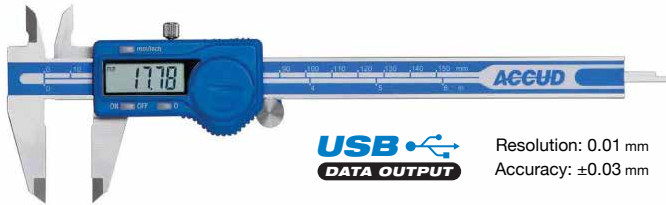

Resolution: 0.01 mm  
Accuracy:  $\pm 0.03$  mm

150 mm Dual Scale Digital Caliper

PN: AC-111-006-12  
**\$119**

200 mm Dual Scale Digital Caliper

PN: AC-111-008-12  
**\$179**

300 mm Dual Scale Digital Caliper

PN: AC-111-012-12  
**\$249**

## Metric Dial Calipers



150 mm Metric Dial Caliper

Graduation: 0.01 mm  
Accuracy:  $\pm 0.03$  mm

PN: AC-101-006-11  
**\$179**

200 mm Metric Dial Caliper

Graduation: 0.01 mm  
Accuracy:  $\pm 0.03$  mm

PN: AC-101-008-11  
**\$209**

300 mm Metric Dial Caliper

Graduation: 0.01 mm  
Accuracy:  $\pm 0.04$  mm

PN: AC-101-012-11  
**\$319**

## Splash Proof IP54 Dual Scale Digital Calipers

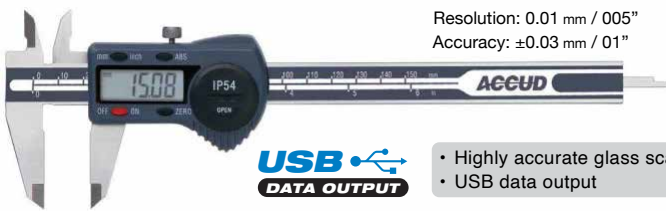

Resolution: 0.01 mm / 005"  
Accuracy:  $\pm 0.03$  mm / 01"



- Highly accurate glass scale
- USB data output

150 mm Dual Scale Splash Proof IP54 Digital Caliper

PN: AC-111-006-11  
**\$149**

200 mm Dual Scale Splash Proof IP54 Digital Caliper

PN: AC-111-008-11  
**\$199**

300 mm Dual Scale Splash Proof IP54 Digital Caliper

PN: AC-111-012-11  
**\$289**

## Coolant Proof IP67 Dual Scale Digital Calipers



**HOT PRICE!**

150 mm PN: AC-112-006-12

150 mm Dual Scale Coolant Proof Digital Caliper

Resolution: 0.01 mm / 005"  
Accuracy:  $\pm 0.03$  mm / 01"

PN: AC-112-006-12  
**\$229**

200 mm Dual Scale Coolant Proof Digital Caliper

Resolution: 0.01 mm / 005"  
Accuracy:  $\pm 0.03$  mm / 01"

PN: AC-112-008-12  
**\$339**

300 mm Dual Scale Coolant Proof Digital Caliper

Resolution: 0.01 mm / 005"  
Accuracy:  $\pm 0.03$  mm / 01"

PN: AC-112-012-12  
**\$499**

## Fractional Metric & Imperial Digital Calipers

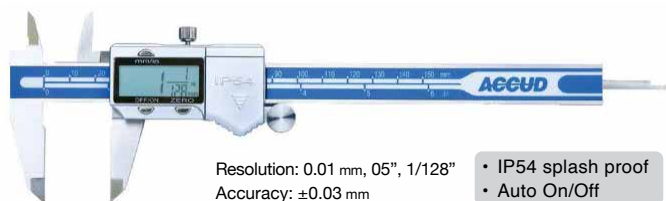

Resolution: 0.01 mm, 05", 1/128"  
Accuracy:  $\pm 0.03$  mm

- IP54 splash proof
- Auto On/Off

150 mm Fractional Imperial Digital Caliper

PN: AC-113-006-11  
**\$159**

200 mm Fractional Imperial Digital Caliper

PN: AC-113-008-11  
**\$219**

300 mm Fractional Imperial Digital Caliper

PN: AC-113-012-11  
**\$299**

## Dual Scale Long Series Digital Calipers

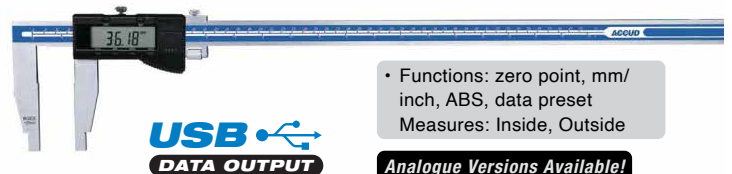

- Functions: zero point, mm/inch, ABS, data preset
- Measures: Inside, Outside

**Analogue Versions Available!**

600 mm Dual Scale Digital Caliper

Resolution: 0.01 mm / 05"  
Accuracy:  $\pm 0.05$  mm / 02"  
Range: Outside 0-620 mm / 0-24.5"  
Inside 20-600 mm / 0-24"  
Jaw Reach: 100 mm

PN: AC-118-024-11  
**\$799**

1000 mm Dual Scale Digital Caliper

Resolution: 0.01 mm / 05"  
Accuracy:  $\pm 0.08$  mm / 03"  
Range: Outside 0-1020 mm / 0-40.2"  
Inside 20-1000 mm / 0-40"  
Jaw Reach: 150 mm

PN: AC-118-040-11  
**\$1529**

## Dial Indicators

### 10 mm Jeweled Bearing Dial Indicator

Graduations: 0.01 mm  
Accuracy: 20 µm

- Jeweled Bearing
- Limit hands
- Lug back



PN: AC-222-010-11  
**\$99**

### 25mm Dial Indicator

Graduations: 0.01 mm  
Accuracy: 20 µm

PN: AC-229-025-11  
**\$129**

### 1" Dial Indicator

Graduation: 0.001"  
Accuracy: 0.004"

PN: AC-225-025-11  
**\$89**

## 25 MM Dual Scale Digital Indicator

Resolution: 0.01 mm / 005"  
Accuracy: 20 µm

- Functions: zero point, Invert measuring, inch/mm direction, data preset, ABS
- USB data output
  - Supplied with flat & lug back



PN: AC-212-025-13  
**\$229**

## Indicator Point Extensions

- Metric Indicator Point Extensions**  
Thread: M2.5x0.45 mm
- 25 mm - PN: AC-270-000-04 **\$19**
  - 50 mm - PN: AC-270-000-09 **\$19**
  - 75 mm - PN: AC-270-000-14 **\$19**
  - 100 mm - PN: AC-270-000-17 **\$25**
- IMPERIAL SIZES AVAILABLE**

## Caliper Attachments

### Caliper Point Extension Kit

Measure slotted, stepped or grooved surfaces in hard to access spaces with four different point configurations. Max Jaw Thickness: 4 mm Probe length: 20 mm



Caliper not included.

PN: GCAK  
**\$49**

### 75 mm Base

Beam Width: 16 mm

PN: AC-179-000-00  
**\$49**

### 100 mm Base

Beam Width: 16 mm

PN: AC-179-000-01  
**\$89**



## Dial Indicators

### 30 mm Dial Indicator

Graduations: 0.01 mm  
Accuracy: ±35 µm

PN: AC-229-030-11  
**\$159**

- 1 mm range per revolution
- Lug and flat back

### 50 mm Dial Indicator

Graduations: 0.01 mm  
Accuracy: ±35 µm

PN: AC-229-050-21  
**\$339**

### 2" Imperial Dial Indicator

Graduations: 0.001"  
Accuracy: 0.008"

PN: AC-225-050-11  
**\$149**



## Dial Test Indicators

- Anti-magnetic metal body
- Jeweled bearing
- Carbide stylus
- Includes 4 & 8 mm clamps

### 0.14 mm Dial Test Indicator

Graduation: 0.001 mm  
Accuracy: ±4 µm

PN: AC-261-014-01  
**\$399**

### 0.80 mm Dial Test Indicator

Graduation: 0.01 mm  
Accuracy: ±13 µm

PN: AC-261-008-11  
**\$139**



## Dial Bore Gauges

### 18-35 mm Dial Bore Gauge

Graduations: 0.01 mm  
Accuracy: ±0.015 mm

PN: AC-251-035-11  
**\$269**

### 35-60 mm Dial Bore Gauge

Graduations: 0.01 mm  
Accuracy: ±0.018 mm

PN: AC-251-060-11  
**\$269**

### 50-160 mm Dial Bore Gauge

Graduations: 0.01 mm  
Accuracy: ±0.018 mm

PN: AC-251-160-11  
**\$269**

### 2-6" Dial Bore Gauge

Graduations: 0.0005"  
Accuracy: 0.0009"

PN: AC-252-060-11  
**\$299**



### 18-160 mm Dial Bore Gauge Set

Range: 18-160mm  
Indicating range: 10 mm  
Graduations: 0.01 mm  
Accuracy:  
18-35mm / ±0.015 mm  
35-60mm / ±0.018 mm  
50-160mm / ±0.018 mm

PN: AC-251-346-13  
**\$789**



## Digital Cylinder Liner Height Gauge

Range: -5 to +5 MM  
Graduations: 0.01  
Accuracy: ±20 µm

- Jeweled Bearing
- Limit hands
- Sturdy metal base



**NEW!**

PN: AC-438-010-11  
**\$279**

## Dial Indicator & Magnetic Stand Kits

### 10 mm Dial Indicator with Fine Adjustment Magnetic Stand

Stem hole: Ø4 mm, Ø8 mm, 3/8"  
Magnetic Force: 60 kgf  
Graduation: 0.01 mm  
Accuracy: ±20 µm

PN: AC-280-000-02  
**\$189**



### 1" Dial Indicator with Fine Adjustment Magnetic Stand

Stem hole: Ø4 mm, Ø8 mm, 3/8"  
Magnetic Force: 60 kgf  
Graduation: 0.001"  
Accuracy: ±20 µm

PN: AC-280-001-02  
**\$189**

## Universal Magnetic Stands

### Fine Adjustment Magnetic Stand

Stem holes: 8 mm  
Magnetic Force: 60 kgf

PN: AC-281-060-01  
**\$89**

### Magnetic Stand

Stem holes: 8 mm  
Magnetic Force: 60 kgf

PN: AC-281-060-02  
**\$79**

### Mini Universal Magnetic Stand

Magnetic Force: 40 kgf  
Stem holes: 8 mm  
Height: 231 mm  
Arm length: 192 mm



PN: AC-286-040-01  
**\$209**

### Universal Magnetic Stand

Stem hole: 8 mm  
Height: 395 mm  
Arm Lengths: 340 mm  
Magnetic Force: 80 kgf



PN: AC-282-080-02  
**\$239**

### Indicator Centering Mount

Mounts Indicator to chuck to indicate alignment between chuck and cylinders or holes.

PN: AC-269-060-01  
**\$49**

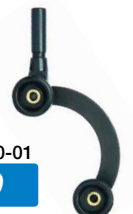



## Contact Tachometer

Rotary Range: 0.5-19,999 rpm  
Linear Range: 0.05-1999.9 m/min  
Power Supply: 2 x AAA  
Weight: 106g

- Includes various coupling attachments



PN: AC-CT900  
**\$139**

## Laser Tachometer

Range: 2.5 - 99,999 RPM  
Sampling Range: 50 - 500 mm  
Power Supply: 2 x AAA  
Weight: 106 g

Supplied with  
45 cm of 3M™  
Reflective Tape.

PN: AC-LT900  
**\$129**



## Digital Sound Level Meter

- Fast & Slow display functions, Continuous & Min/Max functions
- Back-lit LCD
- Programmable Exceedence Alarm

Range: 30-130 db  
Accuracy: 1.5 db  
Resolution: 0.1 db  
Weight: 64g



PN: AC-SLM130  
**\$129**

## Digital Anemometer

- Temperature & Wind Speed display
- Real-time/Max/Ave functions
- Back-lit LCD
- Unit: m/s, km/h, ft/min, Knots, mph

Range: 0.3-30m/s  
Accuracy: ±5%  
Resolution: 0.1m/s  
Weight: 154g



PN: AC-AM30  
**\$129**

## Portable Hardness Tester

Resolution: 1 HLD, 1 HV, 1 HB, 0.1 HRC, 0.1 HRB, 1 HS, 1 MPa

Units: HV, HB, HRC, HRB, HS & tensile strength MPa  
Accuracy: ±8 HLD / 0.8 HRC (HLD=800)  
Min. sample weight: 5 kg (directly) / 2 kg (supported) / 0.1 kg (coupled to plate)  
Min. sample thickness: 5 mm  
Min. sample diameter: 22 mm  
Max. sample roughness: 1.61-Jm(Ra)  
Power: 3 x AAA battery  
Dimensions: 121 x 68 x 30 mm



PN: AC-HL350  
**\$899**

## Shore Hardness Tester

- Meets ISO868, ISO7619, ASTM D2240
- Peak value indicator

Scale: Shore A  
For material: soft plastic, rubber, leather, etc.  
Range: 20-90 HA  
Graduation: 1 HA  
Accuracy: ±1 HA



PN: AC-HSM1A  
**\$389**

## Wood Moisture Meter

Temp. Range: -10-60 °C  
Humidity Range: 0.1 °C RH  
Moisture Range: 2-40/50/60/70%



PN: AC-WMM700  
**\$99**

## FN Coating Thickness Gauge

- Measures thickness of non-magnetic coatings on both magnetic and electrically conductive substrates
- V-type probe for cylindrical work pieces

Range: 0 ~ 1500µm  
Resolution: 0.1µm (0-99.9µm) / 1µm (100-1500µm)  
Accuracy: 2µm (0-100µm) / 3% (100-1500µm)  
Min. measuring area: 25 x 25 mm  
Memory: 30 sets



PN: AC-CFN1500B  
**\$799**

## Laser Distance & Level Meters

- Functions: Distance, Area, Volume, Indirect distance,
- Maximum & Minimum Memory
  - Laser Sight
  - Built-in Spirit Level
  - IP54 Protection Level
  - Back-light LCD Display
  - Battery Power Indicator
  - 1/4"-20 UNC Tripod Mount

Accuracy: 1.5 mm  
Units: Metre/Inch/Foot  
Light spot: Ø8 mm @ 40 m  
Memory: 20 data points  
Power: 2 x AAA  
Weight: 110 g



**HOT PRICE!**  
40 Meter Range  
PN: AC-TM40  
**\$99**



100 Meter Range  
PN: AC-TM100  
**\$279**

## Dual Scale Digital Temperature & Humidity Monitor



- Measuring Unit °C/°F
- Records Max. & min. temperature & humidity
- Time, Date & Month display
- 12 or 24 hr display modes
- Daily alarm function
- Alternating display function

Temperature Range: Indoor: -10 - +50°C  
Humidity Range: indoor 20% - 99%  
Power supply: 1.5V (AAA size) x1  
Size 96W mm x 105H mm

PN: AC-HTC-1  
**\$39**

## Infrared Thermometers & Imaging



- Functions: Min/Max. & Average Differential indication, High & Low Temp. Alarm & 100 Sample Point Memory
- Adjustable Emission Compensation
  - Battery Power Indicator
  - Mutable sample capture alarm
  - Back-light LCD Display
  - 1/4"-20 UNC Tripod Mount
  - Laser Sight

### 950° Infrared Thermometer

Range: -50 to 950 °C  
Accuracy: 1.5% or 1.5 °  
Distance spot ratio: 12:1

PN: AC-IT700  
**\$189**

### 1650°C Infrared Thermometer

Range: -50 to 1650 °C  
Accuracy: 1.5% or 1.5 °  
Distance spot ratio: 12:1

PN: AC-IT1650S  
**\$539**

## Refractometers

### Automotive Refractometer

- Measures concentration levels of Glycol, Propylene Glycol, Battery fluid, Cleaning liquid & Adblue

Range: 0-10%  
Graduations: 0.2%  
Weight: 0.8 Kg

PN: AC-RM50S  
**\$149**

### Engineering Refractometer

- Measures metal working coolant concentration levels

Range: 0-10%  
Graduations: 0.2%  
Weight: 0.8 Kg

PN: AC-RM10  
**\$159**

## Metric Outside Micrometers



**SIZES AVAILABLE UP TO 1000 mm**

- Carbide measuring faces
- Setting standard included
- Ratchet stop

### 25 mm Outside Micrometer

Graduation: 0.01 mm  
Accuracy: 4 µm  
Jaw Reach: 29 mm  
PN: AC-321-001-01  
**\$79**

### 50-75 mm Outside Micrometer

Graduation: 0.01 mm  
Accuracy: 5 µm  
Jaw Reach: 53 mm  
PN: AC-321-003-01  
**\$95**

### 100-125 mm Outside Micrometer

Graduation: 0.01 mm  
Accuracy: 6 µm  
Jaw Reach: 65 mm  
PN: AC-321-005-01  
**\$129**

### 25-50 mm Outside Micrometer

Graduation: 0.01 mm  
Accuracy: 4 µm  
Jaw Reach: 39 mm  
PN: AC-321-002-01  
**\$89**

### 75-100 mm Outside Micrometer

Graduation: 0.01 mm  
Accuracy: 5 µm  
Jaw Reach: 65 mm  
PN: AC-321-004-01  
**\$99**

## Imperial Outside Micrometers



**SIZES AVAILABLE UP TO 40"**

- Carbide measuring faces
- Setting standard included
- Ratchet stop

### 1" Outside Micrometer

Graduation: 0.0001"  
Accuracy: ±0.00015"  
Jaw Reach: 29 mm  
PN: AC-324-001-01  
**\$79**

### 2-3" Outside Micrometer

Graduation: 0.0001"  
Accuracy: ±0.0002"  
Jaw Reach: 53 mm  
PN: AC-324-003-01  
**\$110**

### 1-2" Outside Micrometer

Graduation: 0.0001"  
Accuracy: ±0.00015"  
Jaw Reach: 39 mm  
PN: AC-324-002-01  
**\$89**

### 3-4" Outside Micrometer

Graduation: 0.0001"  
Accuracy: ±0.0002"  
Jaw Reach: 53 mm  
PN: AC-324-004-01  
**\$119**

### 4-5" Outside Micrometer

Graduation: 0.0001"  
Accuracy: ±0.00025"  
Jaw Reach: 65 mm  
PN: AC-324-005-01  
**\$149**

## Micrometer Sets

- Supplied with Calibration certificate



**IMPERIAL SETS AVAILABLE**

### 150-300 mm Micrometer 6 Piece Set

Set of 6 Micrometers  
Range: 150-300 mm  
Graduation: 0.01 mm  
Accuracy: ± 4-6 µm  
PN: AC-321-012-06  
**\$1239**

### 75 mm Micrometer 3 Piece Set

Set of 3 Micrometers  
Range: 0-75 mm  
Graduation: 0.01 mm  
Accuracy: 5 µm  
PN: AC-321-003-03  
**\$229**

### 100 mm Micrometer 4 Piece Set

Set of 4 Micrometers  
Range: 0-100 mm  
Graduation: 0.01 mm  
Accuracy: ± 4-5 µm  
PN: AC-321-004-04  
**\$369**

### 150 mm Micrometer 6 Piece Set

Set of 6 Micrometers  
Range: 0-150 mm  
Graduation: 0.01 mm  
Accuracy: ± 4-6 µm  
PN: AC-321-006-06  
**\$599**

### 300 mm Micrometer 12 Piece Set

Set of 12 Micrometers  
Range: 0-300 mm  
Graduation: 0.01 mm  
Accuracy: ± 4-6 µm  
PN: AC-321-012-12  
**\$1719**

## Coolant Proof Digital Micrometers



- Functions: mm/inch, Origin, zero point, ABS, Hold
- IP65 protection level
  - Carbide measuring faces
  - Ratchet stop.

### 25 mm Coolant Proof IP65 Dual Scale Digital Micrometer

Graduation: 01 mm  
Accuracy: 3 µm  
Jaw Reach: 25 mm  
PN: AC-313-001-01  
**\$259**

### 25-50 mm Coolant Proof IP65 Dual Scale Digital Micrometer

Graduation: 01 mm  
Accuracy: 3 µm  
Jaw Reach: 32 mm  
PN: AC-313-002-01  
**\$279**

## 3 Piece Measuring Tool Set

### 150 mm Digital Caliper

Resolution: 0.01 mm  
Accuracy: ±0.03 mm

### 25 mm Outside Micrometer

Graduation: 0.01 mm  
Accuracy: 4µm

### Beveled Square

Size: 100 x 70mm  
DIN875 grade 0  
Squareness: 7µm



PN: AC-280-000-13

**\$299**

## Micrometer Stand



Micrometer not included.

PN: AC-381-000-00

**\$59**

## Tubular Inside Micrometer Sets



- Carbide measuring faces

### 50-300 mm Metric Tubular Inside Micrometer Set

Head Range: 13 mm  
Graduation: 0.01 mm  
PN: AC-352-012-01  
**\$399**

### 50-600 mm Metric Tubular Inside Micrometer Set

Head Range: 13 mm  
Graduation: 0.01 mm  
PN: AC-352-024-01  
**\$499**

## Telescopic Gauge Set

Handle lengths: 115-137 mm  
Gauge sizes: 8-12.7 mm, 12.7-19 mm, 19-32 mm, 32-54 mm, 54-90 mm & 90-150 mm



PN: AC-951-006-01

**\$89**

## 1/4" Centering Indicator

- For quick and accurate centering in boring and milling set-up
- Jeweled bearing
- Includes with 7 probes



Range: 0-3mm  
Graduation: 0.01 mm  
Size: 150 x 60 x 33 mm

PN: AC-297-003-11  
**\$299**



## 300 MM Dual Scale Digital Output Height Gauge

Range: 0-300 mm/0-12"  
Resolution: 0.01 mm/0.0005"  
Accuracy: ±0.04 mm  
Beam Width: 23 mm  
External Jaw Reach: 80 mm  
Length: 470 mm

PN: AC-181-012-11

**\$579**

## Depth Caliper & Micrometers

### 25 mm Digital Depth Caliper

- USB data output

Resolution: 0.01 mm  
Accuracy: ±0.03 mm

PN: AC-176-001-11  
**\$159**



### 200 mm Digital Depth Caliper

PN: AC-171-008-11  
**\$199**

### 300 mm Digital Depth Caliper

PN: AC-171-012-11  
**\$399**

### 500 mm Digital Depth Caliper

PN: AC-171-020-11  
**\$779**

Resolution: 0.01 mm  
Accuracy: ±0.03 mm

### 0-150 mm Micrometer with Captive Anvils

Accuracy: ±3 µm  
Base size: 101.5 x 17 mm

PN: AC-392-006-01  
**\$389**





## Dual Scale Stainless Rulers



**HOT PRICE!**  
On 600 & 1000 mm Rulers!

### 150 mm Dual Scale Stainless Ruler

Graduation: 0.5 mm, 1 mm, 1/64", 1/32", 1/16"  
PN: AC-990-006-11  
**\$13**

### 300 mm Dual Scale Stainless Ruler

Graduation: 0.5 mm, 1 mm, 1/64", 1/32", 1/16"  
PN: AC-990-012-11  
**\$20**

### 600 mm Dual Yellow Stainless Ruler

Graduation: 0.5 mm, 1 mm, 1/64", 1/32", 1/16"  
PN: AC-990-024-11  
**\$36**

### 1000 mm Dual Yellow Stainless Ruler

Graduation: 0.5 mm, 1 mm, 1/64", 1/32", 1/16"  
PN: AC-990-040-11  
**\$56**

## Straight Edge Rulers



### 500 mm Straight Edge Ruler

Graduations: 1 mm  
Beam Width: 40 mm  
Length: 500 mm  
PN: AC-991-020-01  
**\$239**

### 300 mm Straight Edge Ruler

Graduations: 1 mm  
Beam Width: 40 mm  
Length: 300 mm  
PN: AC-991-012-01  
**\$149**

### 1000 mm Straight Edge Ruler

Graduations: 1 mm  
Beam Width: 50 mm  
Length: 1000 mm  
PN: AC-991-040-01  
**\$499**

## Double Ended Scriber

- Nickel plated with Hardened tips
- Knurled handle



PN: AC-995-009-01  
**\$19**

## Radius Gauge Sets



• Includes concave & convex gauge for each size

### 1-7 mm Radius Gauge Set

Range: 1, 1.25, 1.5, 1.75, 2, 2.25, 2.5, 2.75, 3, 3.5, 4, 4.5, 5, 5.5, 6, 6.5, 7 mm

PN: AC-941-007-34  
**\$39**

### 7.5-15 mm Radius Gauge Set

Range: 7.5, 8, 8.5, 9, 9.5, 10, 10.5, 11, 11.5, 12, 12.5, 13, 13.5, 14, 14.5, 15 mm

PN: AC-941-015-32  
**\$39**

### 15.5-25 mm Radius Gauge Set

Range: 15.5, 16, 16.5, 17, 17.5, 18, 18.5, 19, 19.5, 20, 21, 22, 23, 24, 25 mm

PN: AC-941-025-30  
**\$39**

## Dividers & Calipers



200 mm Inside Spring Caliper  
Range: 18-190 mm  
Length: 200 mm  
PN: AC-982-008-01  
**\$39**



200 mm Spring Divider  
Range: 0-190 mm  
Length: 200 mm  
PN: AC-985-008-01  
**\$39**



200 mm Outside Spring Caliper  
Range: 0-190 mm  
Length: 200 mm  
PN: AC-984-008-01  
**\$39**



200 mm Dividing Caliper  
Range: 0-190 mm  
Length: 200 mm  
PN: AC-986-008-01  
**\$39**

300 mm Inside Spring Caliper  
Range: 18-290 mm  
Length: 300 mm  
PN: AC-982-012-01  
**\$49**

300 mm Spring Divider  
Range: 0-290 mm  
Length: 300 mm  
PN: AC-985-012-01  
**\$49**

300 mm Outside Spring Caliper  
Range: 0-290 mm  
Length: 300 mm  
PN: AC-984-012-01  
**\$49**

300 mm Dividing Caliper  
Range: 0-290 mm  
Length: 300 mm  
PN: AC-986-012-01  
**\$49**

500 mm Inside Spring Caliper  
Range: 25-490 mm  
Length: 500 mm  
PN: AC-982-020-01  
**\$79**

500 mm Spring Divider  
Range: 0-490 mm  
Length: 500 mm  
PN: AC-985-020-01  
**\$79**

500 mm Outside Spring Caliper  
Range: 0-490 mm  
Length: 500 mm  
PN: AC-984-020-01  
**\$79**

500 mm Dividing Caliper  
Range: 0-490 mm  
Length: 500 mm  
PN: AC-986-020-01  
**\$69**

## Wide Base Machinist Squares (Grade 2)

### 100 mm Wide Base Machinist Square

Squareness: (α) 28 μm (β) 30 μm  
Base size: 19H x 12W x 70L mm  
Blade Thickness: 3 mm

PN: AC-845-004-02  
**\$39**

### 150 mm Wide Base Machinist Square

Squareness: (α) 33 μm (β) 35 μm  
Base size: 25H x 16W x 100L mm  
Blade Thickness: 3 mm

PN: AC-845-006-02  
**\$59**

### 200 mm Wide Base Machinist Square

Squareness: (α) 37 μm (β) 40 μm  
Base size: 32H x 16W x 130L mm  
Blade Thickness: 4 mm

PN: AC-845-008-02  
**\$69**

### 300 mm Wide Base Machinist Square

Squareness: (α) 47 μm (β) 50 μm  
Base size: 32H x 19W x 200L mm  
Blade Thickness: 4 mm

PN: AC-845-012-02  
**\$99**



### 600 mm Wide Base Machinist Square

Squareness: (α) 75 μm (β) 80 μm  
Base size: 50H x 30W x 350L mm  
Blade Thickness: 6 mm

PN: AC-845-024-02  
**\$389**

## Thread Gauge Sets



### Metric & Whitworth Thread Gauge

Metric 60° Range: 0.25-6.0 mm  
Whitworth 55° Range: 4-62 TPI

PN: AC-925-062-52  
**\$39**

### Metric Thread Gauge

Metric 60° Range: 0.25 - 6.0 mm

PN: AC-922-006-24  
**\$29**

### Whitworth Thread Gauge

Whitworth 55° Range: 4-42 TPI

PN: AC-924-042-30  
**\$29**

## Circumference Tape



### 60-950 mm Circumference Tape

Range: Dia. 20-300 mm / Cir. 60-950 mm  
Graduation: 0.1 mm

PN: AC-956-012-11  
**\$42**

### 940-2200 mm Circumference Tape

Range: Dia. 300-700 mm / Cir. 940-2200 mm  
Graduation: 0.1 mm

PN: AC-956-028-11  
**\$59**

### 2190-3460 mm Circumference Tape

Range: Dia. 700-1100 mm / Cir. 2190-3460 mm  
Graduation: 0.1 mm

PN: AC-956-044-11  
**\$79**



## Combination Squares

### Combination Square

90° or 45° square  
90° square accuracy: ±8',  
45° square accuracy: ±10'

**Wear Resistant  
Cast Iron Head**



PN: AC-817-090-12  
**\$139**

### Combination Square Set

**Circle Centre Finder** 90° or 45° square  
Accuracy: ±0.15 mm 90° square accuracy: ±8',  
Ruler range: 300 mm / 12" 45° square accuracy: ±10'

**Protractor**  
Range: 0-180°  
Accuracy: ±7'

PN: AC-817-180-02  
**\$269**



## Angle Finders



### 150 mm / 180° Angle Finder

Length: 150 mm  
Graduation: 1°  
Accuracy: ±0.3°

PN: AC-812-005-01  
**\$69**

### 200 mm / 180° Angle Finder

Length: 200 mm  
Graduation: 1°  
Accuracy: ±0.3°

PN: AC-812-006-01  
**\$99**

### 300 mm / 180° Angle Finder

Length: 300 mm  
Graduation: 1°  
Accuracy: ±0.3°

PN: AC-812-008-01  
**\$129**

## Combination Rulers



### 200 mm Digital Combination Ruler

Length: 200 mm  
Range: 360°  
Resolution: 0.1°

PN: AC-821-008-01  
**\$110**

### 300 mm Digital Combination Ruler

Length: 300 mm  
Range: 360°  
Resolution: 0.1°

PN: AC-821-012-01  
**\$129**

## Radius & Hole Gauges

### Radius Gauge Set



Range: 0.5-13 mm  
Accuracy: ±0.05 mm  
Increments: 0.5 mm

PN: AC-942-013-26  
**\$109**

### Small Hole Gauge Set

Range: 3-13 mm



PN: AC-952-004-01  
**\$59**

## Welding Gauges

### Fillet Weld Gauge

Sizes: 3, 4, 5, 6, 8,  
9, 10, 11, 12,  
14, 16, 19,  
22 & 25 mm  
Accuracy:  
0.5 mm

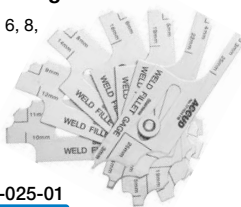

PN: AC-977-025-01  
**\$69**

### Welding Gauge

Range: 0-6 mm  
Porosity Comparison  
Range: 1.5 & 3 mm  
Graduation: 0.5 mm  
Accuracy: 0.5 mm



PN: AC-978-006-01  
**\$69**

### Fillet Weld Gauge

Face width: 4, 5, 6, 7, 8, 9, 10, 12 mm  
Leg width: 4, 6, 7.5, 10, 12, 14, 16, 18 mm  
Accuracy: ±0.5mm

**NEW!**



PN: AC-972-012-01  
**\$39**

### Digital Welding Gauge

Crown Height Range: 5 mm  
Fillet Throat Range: 20 mm  
Angles: 60° 70° 80° 90°  
Accuracy: 0.3 mm

**NEW!**

PN: AC-970-010-11  
**\$229**



## Metric Torque Wrenches

**Highly  
Accurate!**  
±3 Percent



- Supplied with calibration certificate
- Accuracy: ±3%
- Meets ISO6789 & ASMEB107.14

### 5-25 Nm Torque Wrench

Anvil Size: 3/8"  
Length: 275 mm

PN: AC-TWM25Q  
**\$229**

### 10-50 Nm Torque Wrench

Anvil Size: 3/8"  
Length: 275 mm

PN: AC-TWM50Q  
**\$269**

### 40-200 Nm Torque Wrench

Anvil Size: 1/2"  
Length: 505 mm

PN: AC-TWM200Q  
**\$299**

### 70-340 Nm Torque Wrench

Anvil Size: 1/2"  
Length: 695 mm

PN: AC-TWM340Q  
**\$385**

### 10-50 Nm Torque Wrench Set

Set includes 5-25 Nm Torque Wrench (AC-TWM25Q), 100 mm 3/8" extension bar and the following sockets: 2, 2.5, 3, 4, 5, 6, 8 mm hex, T10, T15, T20, T25, T27 & T30 Torx®

PN: AC-STWM25Q  
**\$369**



## Feeler Gauges

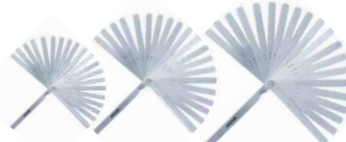

### 200 mm Feeler Gauge 20 Leave Set

Range: 0.05-1 mm  
Length: 200 mm

PN: AC-914-100-20  
**\$49**

### 150 mm Feeler Gauge 20 Leave Set

Range: 0.05-1 mm  
Length: 150 mm

PN: AC-913-100-20  
**\$39**

### 300 mm Feeler Gauge 20 Leave Set

Range: 0.05-1 mm  
Length: 300 mm

PN: AC-915-100-20  
**\$49**

### Dual Scale Angled Feeler Gauge

Metric Range: 0.005 - 0.030 mm  
Imperial Range: 0.127" - 0.762"  
Blade Length: 100 mm



PN: AC-919-030-26  
**\$49**

### Tapered Feeler Gauge

Metric Range: 0.03-1.00mm  
Blade Length: 100 mm

- Meets DIN2275
- Accuracy: ±(3+T/80) μm,

PN: AC-912-100-32  
**\$29**

## Feeler Tapes

Size: 13 mm x 5 m  
Accuracy: ±4 μm



### 0.02 mm Feeler Tape

PN: AC-916-002-01  
**\$49**

### 0.04 mm Feeler Tape

PN: AC-916-004-01  
**\$49**

## Protractor & Levels

### Digital Level & Protractor

- Magnetic V-groove Base



PN: AC-722-360-01  
**\$229**

Resolution: 0.05°  
Accuracy : ±0.1°(at 0°/90°/180°/270°)  
±0.2°(other direction)  
Size: 150 x 60 x 33 mm

### Digital Level

- Magnetic base

Range: 0-360°  
Resolution: 0.1°  
Dimensions: 59 x 28 mm  
Accuracy: ±0.1°  
±0.2°(other directions)



PN: AC-721-180-01  
**\$129**

### 600 mm Digital level

- Functions as level or protractor
- Absolute horizon memory
- Back-light Display
- Magnetic base



Units: Degrees, Slope %, mm/m & In/Ft Pitch.  
Resolution: 0.1°

PN: AC-725-360-01  
**\$209**

## Deburring Hex Body Handle with Pocket Clip

Aluminium 8 mm Hex body handle with pocket clip & non-replaceable C-10 blade.



**\$9**  
PN: GD86110

## Hex Body Handle with C-10 Blade

10 mm Hex Handle Deburring Tools A/F Hex. Aluminium body handle with replaceable GDSC10 blades.



**\$19**  
PN: GD86060

## 3.2 MM Quick Release Mini Deburrer

Holds all standard 3.2 mm deburring blades. Includes replaceable 3.2 Mm (C-10) blade.



**\$24**  
PN: GDET2

## 6 MM Heavy Duty Quick Release Deburrer

**HEAVY DUTY  
MSS HSS  
BLADE!**

- Ideal for stainless & mild steel
- Removable cap for blade storage

6 mm Heavy Duty Quick Release Handle (GDSRSDMK) with 6 mm heavy duty blade (GDSR10S).



**\$37**  
PN: GDSRSDMKK

## Double Deburrer

- Deburrs both sides of workpiece at same time
- Perfect for sheet metal finishing
- Finger guard

**REPLACEABLE  
BLADES**



**\$31**  
PN: GDDB

## 24 Piece Deburring Set

Set includes a comprehensive range of Multi-Component and Quick Release Handles, 2.6, 3.2, & 6 mm Blades, Double Sided, Key-Way, Countersink Blades and a ceramic blade.

**DEBURR ANYTHING  
FROM PLASTIC TO  
STAINLESS STEEL!**



**\$299**  
PN: GD88030

## Quick Release Handle with 3.2 MM MC-blades

3.2 mm Standard Quick Release Handle (GDSDSDMK) with Multi-cutting Edge

**\$39**  
PN: GD38333

Deburring blades:



GDSDSDMK10, (steel, aluminium, copper, zinc),  
GDSDSDMK20, (steel, aluminium, copper, zinc)  
GDSDSDMK101 (cast iron, brass)



## Ergonomic Deburring Tool & Blade Set

Quick Release Handle with 10 assorted 3.2 mm blades. Storage for blades in handle.

**\$53**  
PN: GD88040

Set Includes:  
3.2 mm Standard Quick Release Handle (GDSDSDMK)

Standard 3.2 mm Deburring blades:



2 x GDSC10 (aluminium, copper, zinc),  
2 x GDSC101 (steel & aluminium),  
2 x GDSC15 (stainless steel & hard plastics),  
2 x GDSC20 (cast iron, brass),  
1 x GDSC30 (aluminium, copper, zinc),  
1 x GDSC35 (aluminium, copper, zinc)



## Telescopic Multifunction Deburring Tool

Includes Multi-Component Handle (GDSTSDMK) & blade holder and the following standard 3.2 mm deburring blades:

**\$59**  
PN: GD38325



GDSC10 (aluminium, copper, zinc),  
GDSC15 (stainless steel & hard plastics),  
GDSC20 (cast iron, brass),  
GDSC30 (aluminium, copper, zinc),  
GDSC35 (General purpose)



## Hex-Drive Pipe Deburring Bits

- Quickly deburr internal & external edges of cylindrical work pieces with superior results.
- Can be used with power tools, by hand or with a 1/4" Hex Drive Ratchet Handle (PN: GD46030)
- Made from (M2 Grade) HSS



Drill not included.

OD Range: 16-31 MM  
ID Range: 16-35 MM  
Angle: 45°

**\$110**  
PN: GD16319-2F

OD Range: 22-42 MM  
ID Range: 22-46 MM  
Angle: 60°

**\$159**  
PN: GD22426-2F

OD Range: 16-31 MM  
ID Range: 16-35 MM  
Angle: 60°

**\$110**  
PN: GD16316-2F

OD Range: 40-58 MM  
ID Range: 40-62 MM  
Angle: 45°

**\$199**  
PN: GD40589-2F

OD Range: 22-42 MM  
ID Range: 22-46 MM  
Angle: 45°

**\$139**  
PN: GD22429-2F

OD Range: 40-58 MM  
ID Range: 40-62 MM  
Angle: 60°

**\$229**  
PN: GD40586-2F

## Workshop Stools & Creepers

### Workshop Stool

- 100 mm swivel casters, with 2 lockable
  - Centre mounted pull out drawer
  - Metal Frame
- Size: 670L x 330D x 380H mm  
Max. Load: 130 Kg



**PULL OUT DRAWER**

**\$159**  
PN: GWS

### Adjustable Hydraulic Stool

- Adjustable seat height
- 4" swivel wheels (2 lockable)
- Wide HDPE double walled seat
- Bottom Organiser tray
- Metal Frame

Height Range: 450-560 mm  
Size: 540L x 390W x 560H mm  
Max. Load: 150 Kg



**STEEL FRAME →**

**\$239**  
PN: GAHS

### Mechanics Creeper

- Size: 1005 x 470 x 135 mm
- Wheel Size: 75 x 25 mm
- Integrated side trays
- Made in Taiwan

**STEEL REINFORCED CASTER MOUNTS**



**150 kg Load Rating**

**\$189**  
PN: GCR40

## Workshop Trolleys

### Plastic Parts Trolley

- Rounded corners protect walls & furniture
- Soft 4" PVC wheels (2 lockable)
- Deep Pocket shelves
- Handles both ends

Size: 82 x 47 x 105cm  
Capacity: 130 Kg



**MADE FROM HDPE PLASTIC**

**\$249**  
PN: GT3SP

### Compact Heavy Duty Parts Trolley

- 3 Shelves
- 1.6 MM steel uprights.

Size: 410W x 760D x 885H mm (including handle)



**MAX RATING 150KG**

**\$299**  
PN: GT3S

### Heavy Duty Parts Trolley

- 3 Shelves, side container and drawer
- 1.6 MM steel uprights.

Size: 470W x 785D x 825H mm (including handle)



**MAX RATING 150KG**

**\$359**  
PN: GT3SD

### Heavy Duty Parts Trolley

- 3 Shelves, side container and drawer
- Enclosed front & rear for extra rigidity.
- Takes up to 100 Kg per shelf, max total weight 200 Kg per unit.

Size: 500W x 873D x 880H mm (including handle)



**LOAD RATING 200KG**

**\$599**  
PN: CTH5086

## Wall mountable Pivot Drawers

Pivot drawers slot together vertically or horizontally, to be safely mounted to walls or benches. Windowed drawers keep all your spare parts in plain sight with reduced exposure to dust, moisture or other contaminants.

### 8 Compartment Pivot Drawer Set

Size: 300W x 200H x 67D mm



**\$39**  
PN: FO308

### 6 Compartment Pivot Drawer Set

Size: 300W x 250H x 106D mm



**\$39**  
PN: FO306

### 5 Compartment Pivot Drawer Set

Size: 600W x 150H x 123D mm



**\$52**  
PN: FO605

### 4 Compartment Pivot Drawer Set

Size: 600W x 200H x 167D mm



**\$69**  
PN: FO604

### Single Sided 46 Bin Pivot Drawer Cart

- Includes 2 x FO308, 2 x FO306, 2 x FO605 & 2 x FO604, 46 bins in all

**\$899**  
PN: MSFO4568

### Double Sided 92 Bin Pivot Drawer Cart

- Includes 4 x FO308, 4 x FO306, 4 x FO605 & 4 x FO604, 92 bins in all

**\$1399**  
PN: MSFO4568X2

Cart Size: 690W x 560D x 1460H mm

**UP TO 92 BINS OF STORAGE!**



Additional freight charges may apply.

## HB-Series Storage Bins

### Geiger Small Short Bin

Size: 105W x 137D x 76H mm



**\$6 ea**

- PN: HB210B
- PN: HB210R

### Geiger Small Bin

Size: 105W x 187D x 76H mm



**\$7 ea**

- PN: HB220B
- PN: HB220R

### Geiger Medium Bin

Size: 140W x 276D x 127H mm



**\$13 ea**

- PN: HB230B
- PN: HB230R

### Geiger Large Short Bin

Size: 210W x 273D x 178H mm



**\$22 ea**

- PN: HB239B
- PN: HB239R

### Geiger Medium Duplex Bin

- Includes duplex divider

Size: 279W x 276D x 127H mm



**\$19 ea**

- PN: HB235B
- PN: HB235R

### Geiger Large Duplex Bin

- Includes duplex divider

Size: 420W x 375D x 178H mm



**\$32 ea**

- PN: HB250B
- PN: HB250R

## Wall Storage Kit

Includes 2 Panels, 40 x HB210 Bins, screws & wall plugs.

- PN: HP1KITB
- PN: HP1KITR

**\$245 ea**



## Mobile HB Storage Cart

Make your HB bins mobile with this hanging display unit with caster wheels (2 with brakes). This is an excellent time and space saver for any workshop.

HB Bins are easily detached from the storage cart, making it easy to take only what you need to the work area, while keeping items organized.

Includes Heavy Duty Galvanized Steel Cart with 72 x HB220 and 32 x HB230 bins, in combination of ● Blue or ● Red. Overall Size: 740W x 560D x 1460H mm

**CUSTOM LOAD-OUTS ALSO AVAILABLE!**

Additional freight charges may apply.

**\$1199**

PN: MS20020K



## Wall Mountable

All HB series bins can be wall mounted when combined with HP Hanging Panels (see HP1 & HP1KITB/R). HP Panels can be tiled together and mounted horizontally or vertically.

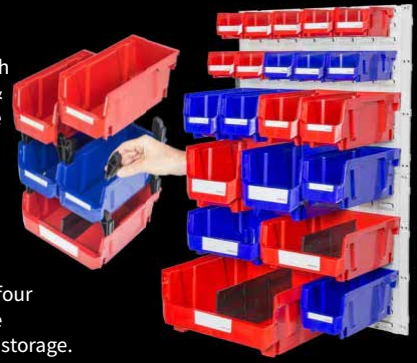

## Free Standing Bench Storage

Included with all HB bins are four interlocking legs which create free-standing versatile bench storage.

## Set of 2 HB-Series Hanging Panels

Includes 2 Panels, screws & wall plugs. Panel size: 605W x 455H x 8D mm



**\$83**

PN: HP1

## Heavy Duty A-Series Parts Cabinets

### ST2



Drawer Size: 120W x 210D x 55H mm

**60 Drawer Parts Cabinet**

**\$669**

PN: ST2460

Size: 586W x 222D x 937H mm

### A5



Drawer Size: 163W x 289D x 69H mm

**36 Drawer Parts Cabinet**

**\$629**

PN: A5336

Size: 586W x 290D x 937H mm

**24 Drawer Parts Cabinet**

**\$489**

PN: A5324

586W x 290D x 640H mm

### A7



Drawer Size: 120W x 218D x 69H mm

**48 Drawer Parts Cabinet**

**\$499**

PN: A7448

Size: 586W x 222D x 937H mm

**24 Drawer Parts Cabinet**

**\$339**

PN: A7324

Size: 444W x 222D x 642H mm

**16 Drawer Parts Cabinet**

**\$249**

PN: A7416

Size: 586W x 222D x 350H mm

### A8



Drawer Size: 90W x 218D x 70H mm

**60 Drawer Parts Cabinet**

**\$599**

PN: A8560

Size: 586W x 222D x 937H mm

**32 Drawer Parts Cabinet**

**\$359**

PN: A8432

Size: 466W x 222D x 642H mm

**15 Drawer Parts Cabinet**

**\$239**

PN: A8315

Size: 355W x 222D x 415H mm

## Heavy Duty Lockable A7 Parts Cabinets

Each drawer comes with 2 movable dividers.  
The front face of each drawer features a window.

### Lockable 48 Drawer Parts Cabinet

Size: 586W x 270D x 970H mm

**\$799**

PN: A7448D

### Lockable 24 Drawer Parts Cabinet

Size: 444W x 270D x 677H mm

**\$669**

PN: A7324D



**LOCKABLE DOORS**

## Steel HD Series Parts Cabinets

HD cabinets take up to 100 kg per shelf. Each drawer comes with 2 movable dividers and is acid and oil resistant. The front face of each drawer features a window which makes it easy to identify the contents.

### 15 Drawer Steel Parts Cabinet

Size: 880W x 400D x 440H mm  
Drawer size: 160W x 110H x 410D mm



**\$575**

PN: HD515

### 18 Drawer Steel Parts Cabinet

Size: 550W x 400D x 880H mm  
External Size: 160W x 110H x 410D mm

### 30 Drawer Steel Parts Cabinet

880W x 400D mm x 880H mm  
External size: 160W x 110H x 410D mm



**\$699**

PN: HD318



Additional freight charges may apply.

**\$945**

PN: HD530

## HD-Series Storage Bins

The 60 drawer NHD560 takes up to 600 kg total weight and up to 100 kg per shelf. Each drawer comes with 2 movable dividers and is acid and oil resistant. The window front makes it easy to identify the contents.  
Size: 880W x 400D x 1725H mm



The HD drawers are designed to be fully opened and not fall out, even at the 10 kg maximum weight limit and feature transparent windows for easy parts identification.

Each drawer comes with 2 movable dividers and can take up to 7 Dividers. All is acid and oil resistant.

### HD Drawer

External Size: 160W x 410D x 110H mm  
Internal size: 140W x 370D x 100H mm



**\$20**

PN: HD1641

### 60 Drawer HD Series Steel Parts Cabinet

The 60 drawer NHD560 takes up to 600 kg total weight and up to 100 kg per shelf. Each drawer comes with 2 movable dividers and is acid and oil resistant. The window front makes it easy to identify the contents.  
880W x 400D x 1725H mm



Additional freight charges may apply.

**\$1799**

PN: NHD560

## Multi Function Storage Bin

Includes bin and lid. Made from high impact polypropylene.  
Size: 450W x 360D x 250H mm

The NHA3645 bins can be stacked without a lid or nested together when not being used.

Rotate and nest bins together.

Stack bins with no lid needed.



**\$39**

PN: NHA3645K



### HD Drawer Dividers

Packet of 10

**\$20**

PN: HD1641DIV



### 30 Drawer Parts Cabinet

980W x 400D x 1010H mm  
(inc handle and caster wheels)



**\$1159**

PN: NHD530

## Multi-Function Bins & Crates

### Jumbo Storage Bin

Includes removable two stage folding lid. Made from impact resistant polypropylene.  
Size: 395W x 635D x 335H mm



**TAKES UP TO 30KG!**

**50 LITRE CAPACITY!**

**\$75**

PN: HB4068B

### Foldable Crates

Stackable in both collapsed and extended configuration

Size: 535W x 360D x 280H mm  
Collapsed Height: 50 mm

**SPACE SAVING COLLAPSIBLE DESIGN**



**\$49**

PN: FB5336B



## Pick & Pry Tools and Screwdrivers

### Precision Two-Way Ratcheting Screwdriver Set

Set Includes 30-Tooth Full Aluminium Ratcheting Screwdriver, H4 mm x 50 mm L Bits in  
 Phillips: #000 / #00 / #0 / #1 / #2 / #3  
 Torx: T5 / T6 / T7 / T8 / T9 / T10 / T15 / T20 / T25  
 Slotted: 1.0 / 1.5 / 2.0 / 2.5 / 3.0 / 4.0 / 6mm  
 Hex: H1.5 / H2.0 / H2.5  
 Square: S1/S2



**30 TOOTH RATCHET**

**31-Piece Set**  
**\$69**  
 PN: MP002026

### Precision Screwdriver Set

- Made from industrial grade Chrome Vanadium Steel Alloy (Cr-V) for superior durability and rust resistance.
- Permanent magnetic tips enable placement of fasteners in confined areas.
- Soft PP+TPV Rubber Grip provides users with greater comfort and torque application.



Phillips Sizes: 00, 0 & 1  
 Slotted Sizes: 1.6, 2, 2.4 & 3.15 mm  
 Shank: 60 mm

**7-Piece Set**  
**\$59**  
 PN: MP002007

### Torx Screwdriver Set

- Permanent and strong magnetic tips to firmly hold screws.
- PP+TPV Rubber Soft Grip Handle provides users with greater comfort and torque application.
- Patented SVCM Satin Chrome Plated Steel.
- Meets and even exceeds ANSI standards for performance and quality.



Set Includes: T10, T15, T20, T25, T27, T30, T40  
 Shank: 100 mm

**7-Piece Set**  
**\$65**  
 PN: MP002010

### Precision Hook & Pick Set

Includes full hook, right angled hook, angled hook and straight pick.



**4-Piece Set**  
**\$29**  
 PN: MP002006

### 19-in-1 Multi Bit Ratchet Screwdriver

Includes an assortment of 16 tips:  
**1/4" Hex x 75 mm double end bits:**  
 3 mm Slotted & Phillips #0  
 5 mm Slotted & Phillips #1  
 6.5 mm Slotted & Phillips #2  
 1/8" Hex & Hex 3/16"  
 T15 Torx & T20 Torx  
 Pozi #1 & Pozi #2  
 Square #1 & Square #2  
**5/16" Hex x 75 mm double end bits:**  
 Phillips #3 & Slotted  
**Nutdrivers:**  
 2 x Nutdrivers on tube 1/4" x 5/16"  
 1 x Nutdriver on ratchet 7/16"



**25 TOOTH RATCHET**

**\$39**  
 PN: MP002001

### 7-in-1 Ratcheting Nut & Screwdriver Driver

Includes 25-Tooth Ratchet Screwdriver with storage for two double ended bits: Philips #1 / 5 mm slot & Philips #2 / 6mm slot. It also features a Stainless Steel Collar with 1/4 & 5/16 Hex tips with magnetised bit tips to hold screws.



**25 TOOTH RATCHET**

**\$35**  
 PN: MP002025

### Roll Head Pry Bar Set

- Heavy duty forged steel alloy
- Supplied in foam tray
- Black oxide finish



4-Piece pry bar set includes 150, 300, 405 & 510 mm sizes

**4-Piece Set**  
**\$139**  
 PN: MP009105

### Slotted & Phillips Screwdriver Set

- Made from industrial grade Chrome Vanadium Steel Alloy (Cr-V) for superior durability and rust resistance.
- PP+TPV Rubber Soft Grip Handle provides users with greater comfort and torque application.
- Permanent magnetic tips enable placement of fasteners in confined areas.

8-Piece Set Includes:

6.5 mm slot / 38 mm shank #2 Philips / 38 mm shank  
 5 mm slot / 75 mm shank #1 Philips / 75 mm shank  
 6 mm slot / 100 mm shank #2 Philips / 100 mm shank  
 8 mm slot / 150 mm shank #3 Philips / 150 mm shank



**8-Piece Set**  
**\$69**  
 PN: MP002008

## Magnetic Parts Trays

- Specially designed swiveling rim keeps non-magnetic parts from falling out when hung vertically.

Set includes 150 mm circular magnetic tray & 240 x 150 mm magnetic tray

Weight capacity: 2 kg (magnetic)



2-Piece Set

**\$75**

PN: MP009014

## 16L No-Spills Oil Drain Pan

- Specially designed to easily drain and dispose of waste oil with it's specially designed anti-splash spout.
- Made from durable high density polyethylene.

**\$39**

PN: MP009063

Size: 580L x 480W x 150H mm  
Capacity: 16L



## Fabricating Tools

### Curved Jaw Locking Pliers

Jaw grip range: 25 mm  
Length: 250 mm



**\$28**

PN: MP003002

### Locking Sheet Metal Clamp Pliers

Jaw grip range: 25 mm  
Jaw face: 80 x 40 mm  
Length: 200 mm



**\$37**

PN: MP003064

### Locking C-Clamp

▪ Swivel Pads  
Jaw Face: 30 x 30 mm  
Internal Jaw Size: 90W x 70L mm  
Length: 290 mm



**\$46**

PN: MP003063

### Straight Jaw Locking Pliers

Jaw grip range: 25 mm  
Length: 250 mm



**\$28**

PN: MP003062

### Set of 6 Pliers

▪ Forged Steel  
6 piece set includes Large & Small Slip Joint Pliers, Diagonal Cutting Pliers, Long Nose Pliers, Lineman's Pliers, Groove Joint Pliers



**\$148**

PN: MP003059

### Ball Peen Hammers

- Fibreglass handle with soft anti-slip vibration absorbing TPR grip
- Drop-forged steel head with sand-blasted finish



16 Oz / 325 mm

**\$39**

PN: MP004007

24 Oz / 380 mm

**\$49**

PN: MP004008

### 22 oz / 30 cm Soft Hammer

- Shock & Spark Resistant Head
- Non-marring, Double ended Soft Mallet



**\$49**

PN: MP004026

### 16 oz Claw Hammer

- Fibreglass handle with soft anti-slip vibration absorbing TPR grip
- Drop-forged steel head with sand-blasted finish



**\$39**

PN: MP004005

### Stainless Multi-Purpose Shears

- Serrated blades to ensure precise and clean cuts
- Lower blade has an anti-slip wire cutting notch
- Manufactured from high grade Japanese stainless steel
- Ergonomically designed for both left & right handed users



HIGH-GRADE  
JAPANESE  
STAINLESS STEEL

**\$35**

PN: MP010027

### Stainless Workshop Scissors

- Serrated blades to ensure precise and clean cuts
- Design integrates wire stripper and terminal crimper
- Manufactured from high grade Japanese stainless steel



HIGH-GRADE  
JAPANESE  
STAINLESS STEEL

**\$45**

PN: MP010025

Wire Striping Capacity: 16-12 AWG  
Wire Cutting Capacity 3.5 mm (Aluminium & Copper)  
Notch Blade Size: 8.5mm (0 AWG)



## Hex Key Wrench Sets

### Metric Two-Way T-Handle Ball End Hex Key Set

Sizes: 2, 2.5, 3, 4, 5, 6, 8, 10 mm.

Hardened CR-V

8-Piece Set

**\$95**

PN: MP001044



### Imperial T-Handle Ball End Hex Key Set

Sizes: 5/64", 3/32", 1/8", 5/32", 3/16", 1/4", 5/16" & 3/8".

Hardened CR-V

8-Piece Set

**\$95**

PN: MP001045



### Metric T-Handle Ball End Hex Key Set

Sizes: 2, 2.5, 3, 4, 5, 6, 8, 10 mm.

Hardened CR-V

8-Piece Set

**\$79**

PN: MP001042



### Folding Imperial & Metric Hex Key Set

Metric set includes 1.5, 2, 2.5, 3, 4, 5, 6, 8 mm  
Imperial set includes 5/64", 3/32", 7/64", 1/8", 9/64", 5/32", 3/16", 7/32", 1/4", 17 sizes in total.  
Length: 200 mm

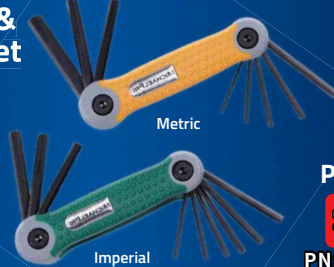

Hardened CR-V

Pack of 2

**\$39**

PN: MP001007

### Metric & Imperial Short Arm Hex Key Set

Metric: 1.5, 2, 2.5, 3, 4, 5, 6, 7, 8 & 10 mm  
Imperial: 1/16, 5/64, 3/32, 1/8, 5/32, 3/16, 7/32, 1/4, 5/16 & 3/8 inches



Hardened CR-V

20-Piece Set

**\$39**

PN: MP001046

## Wrenches

### Combination Wrenches

- Combination Wrenches with patented super comfortable spiral grip design
- The 12-Point closed end doubles the access angle compared to 6-point
- 0 & 15 degree taper at the open end allows better accessibility

12 POINT

Super Comfortable Wide Body Grip

15° Angled Closed End

Tapered Open End



### 11-in-1 Ratchet Wrench with Interchangeable Gear Rings

- Our gear ring spanner replaces the need to carry a full range of wrenches. Simply insert the desired gear ring and start using it!

Includes 90 Tooth Double End Ratchet Wrench, 8, 9, 10, 11, 12, 13, 14, 15, 16, 17 & 19 mm gear rings and a durable storage case.

Quick-Release Button

6 POINT



12-Piece Set

**\$115**

PN: MP001204

### 1/4" & 3/8" 2 Way T-Handle Spinner Wrench Set

- Second square drive on handle
- 3 position adjustable spinner grip



2-Piece Set

**\$149**

PN: MP009015

### Auto Adjusting Crowsfoot Wrenches & Adapters

This spring-loaded, self adjusting design tightens it's grip as force is applied, making it ideal for damaged extraction bolts and pipe work.



### Auto Adjusting Crowsfoot Wrench

- Constructed from high grade Chrome Vanadium (CR-V) steel



Range: 8 to 32 mm

**\$69**

PN: MP001206

### Set of 3 Auto Adjusting Crowfoot Wrench Adapters

- Multiple square drive attachment point make ideal for confined spaces.

Range: 5-32 mm



**\$99**

PN: MP001205

### Metric Combination Wrenches

8 piece set includes 8, 10, 11, 12, 13, 14, 17 & 19 mm

**\$119**

PN: MP001015

### Imperial Combination Wrenches

8 piece set includes 5/16", 3/8", 7/16", 1/2", 9/16", 5/8", 11/16" & 3/4"

**\$119**

PN: MP001014



# Ratchet Wrenches and Adapters

## Quick Release Ratchet Set

- 90 teeth ratcheting mechanism allows for ease of movement in today's tight and confined engine compartments.
- Ratchets supplied in foam tray.
- Chrome Vanadium steel
- Meets and exceeds ASME torque performance standards.

Set includes:  
1/4", 3/8", and  
1/2" drive ratchets.  
Ratcheting mechanism:  
90 teeth (4° swing)



**90  
TOOTH  
RATCHET**

**3-Piece Set**  
**\$98**  
PN: MP006009

## Extendable Flex-Head Ratchet Set

- Push-Button socket release
- 72 tooth ratcheting mechanism (5° swing)
- Extendable handles
- 180° Flex-Head for accessing tight corners or spaces
- Drop-forged and heat treated chrome vanadium (CR-V) for superior durability and lifespan
- Satin Chrome finish
- Ratchets supplied in foam tray

1/4" ratchet length: 140 to 185 mm  
3/8" ratchet length: 185 to 245 mm  
1/2" ratchet length: 225 to 310 mm  
Ratcheting mechanism:  
72 teeth (5° swing)  
Ratchet head range;  
180° (5° detents)



**72  
TOOTH  
RATCHET**

Extendable  
Handle

**3-Piece Set**  
**\$189**  
PN: MP001210

## Impact Adapter & Reducer Set

- Meet or exceed DIN & ANSI standards.
- Made from Chrome Molybdenum Steel

4-piece set includes:  
1/4"(F) to 3/8"(M)  
3/8" (F) to 1/4"(M)  
3/8"(F) to 1/2"(M)  
1/2"(F) to 3/8"(M)



**4-Piece Set**  
**\$26**  
PN: MP005023

## Hex Drive Impact Socket Adapter Sets

- Meet or exceed DIN & ANSI standards.
- Made from Chrome Molybdenum Steel

Input: 1/4" Hex  
Output: 1/4", 3/8" & 1/2" Sqr



**75 mm  
Adapter Set**  
**\$25**  
PN: MP005020

**150 mm  
Adapter Set**  
**\$29**  
PN: MP005021  
Sockets not included.

## 3/8" Drive Flex Head Ratchet Wrench & Socket Set

- 72 tooth ratcheting mechanism (5° swing)
- Standard & deep sockets included to access fasteners in a wider range of areas.
- Can be used as breaker bar by engaging ratchet lockout
- Lockable flex-head
- Quick Release socket button
- Meets ASME torque performance standards.
- Set supplied in foam tray.

Set includes:  
1 x 3/8" Drive Flex Head Ratchet  
Standard & deep sockets in  
8, 10, 12, 13, 14, 15,  
17, 19 & 21 mm Sizes



**72  
TOOTH  
RATCHET**

**6  
POINT**

Hardened  
**CR-V**

**19-Piece Set**  
**\$119**  
PN: MP001228

## Portable Socket Organizer

Size: 332 x 154 x 25 mm  
80 socket organizer holds:  
20 x 1/4" Dr per rail  
20 x 3/8" Dr per rail  
20 x 1/2" Dr per rail  
10 x 3/8" Dr &  
10 x 1/2" Dr per rail



**\$72**  
PN: MP014006

## 3 Piece Aluminium Socket Rails

Capacity: 16 x 1/4" clips, 16 x 3/8" clips and  
14 x 1/2" clips, 46 sockets total  
Size: 395 x 26 mm



Sockets not included.

**\$59**  
PN: MP014001

# Extension Breaker Bars

These time and space saving breaker bars featuring a square drive socket in the handle and a centre detented in knuckle. Enabling it to both function as a breaker bar and extension bar.



Square Drive  
Socket End

**180° Knuckle with  
Centre Detent**

Manufactured from extremely durable and  
corrosion-resistant mirrored chrome vanadium steel.

**3/8" Drive x 300 mm  
Extension Breaker Bar**

**\$29**  
PN: MP007001

**1/2" Drive x 450 mm  
Extension Breaker Bar**

**\$39**  
PN: MP007003

**Set of 3 Extension  
Breaker Bars**

Set includes:  
1/4" drive 150 mm long breaker bar  
3/8" drive 300 mm long breaker bar  
1/2" drive 450 mm long breaker bar

**\$129**  
PN: MP007004

## Gasket Punch Set

14 Piece set includes:  
1/4", 5/16", 3/8", 7/16", 1/2", 5/8",  
3/4", 7/8", 1", 1 1/8", 1-1/4",  
1-3/8" & 1-1/2"



**\$110**  
PN: GGPS

## Hook & Pick Set

Includes Straight,  
Right-Angle,  
Curved &  
Hooked Picks.



**\$36**  
PN: GXHP4

## Helping Hand Magnifier

- Features a sturdy cast iron base, two articulated alligator clamps and magnifying glass.



Main Beam: 115 mm  
Arm Reach: 75 mm  
Lens Dia.: 60 mm

**\$33**  
PN: GHMM

## Socket Sets

### 1/4" Socket Set

- Chrome Vanadium Steel

Set includes Ratchet Wrench,  
Driver Handle, 50 mm Extension,  
Tee Bar & Universal Joint.

**Standard Socket sizes:**

4, 4.5, 5, 5.5, 6, 7, 8, 9, 10, 11, 12,  
13, & 14 mm

**Hex Bits:** 3, 4, 5 & 6 mm

**Phillips Bits:** #1, #2, & #3

**Pozidriv Bits:** #1, #2 & #3

**Slotted Bits:** 3, 4 & 6 mm

**Torx® Bits:** T8, T9, T10 T15, T20,  
T25, T27, T30, & T40



**40  
PIECE  
SET**

**HOT  
PRICE!**

**\$89**  
PN: GXSS1440

### 3/8" Socket Set

- Chrome Vanadium Steel

Set includes Ratchet Wrench,  
75 & 150 mm Extension Bars and  
Universal Joint.

**Standard Socket sizes:**

8, 9, 10, 11, 12, 13, 14, 15, 16, 17,  
18, 19, 20, 21 & 22 mm

**Deep Socket sizes:**

10, 11, 12, 13, 14, 15, 17 & 19 mm

**Spark Plug Socket:** 16 & 21 mm



**29  
PIECE  
SET**

**HOT  
PRICE!**

**\$99**  
PN: GXSS3829

## Precision Screwdriver Set

65 piece set includes:

**4 mm & 1/4" Driver Handles &  
Extension Bars**

**Hex:** 0.9, 1.3, 1.5, 2.0, 3, 4, 5 & 6 mm

**Slotted:** 1.0 & 1.5, 2.0, 2.5, 3, 4, 5, 6 & 7 mm

**Pozidriv:** #0 to #3

**Phillips:** 000 to 3

**Square:** 0 to 3 mm

**Sockets:** 5 to 13 mm

**Torx®:** T5, T6, T7, T8, T9, T10,  
T15, T20, T25, T30 & T40



**65  
PIECE  
SET**

**\$39**  
PN: GXBS1465

## Magnetic Clean-Up Tools

### Magnetic Clean-Up Wand

Capacity: 6.30 Kg  
Length 400 mm  
Weight 0.470 Kg



**\$89**  
PN: MW001

### Magnetic Broom

- Side mounted wheels for easy use over wide areas
- Telescopic main shaft
- Easy release trigger on main shaft
- Wide section magnetic pickup

Handle Length:  
720-1035 mm  
Head width: 377mm

**\$155**  
PN: MB001



### Magnetic Reach Extender

Head size: 96 MM  
Length: 960 MM  
Capacity: 4.5 Kg



**\$115**  
PN: MRE001

## Gear & Bearing Splitting Combination Set

### Small Bearing Separator

Jaw Range: 30-50 MM  
Working Range: 0-135 MM

### Large Bearing Separator

Jaw Range: 50-75 MM  
Working Range: 0-180 MM

Includes Centre Adapter.

**S45C Drop Forged hardened  
Main Beam and  
Bearing Separators.**



**\$229**  
PN: GBTK

## Multi-Hydraulic Gear Puller Kit

### Bearing Separator

S45C Drop Forged hardened  
Bearing Separator.

Working Range: 0-370 MM  
Jaw Range: 75-105 MM

### Gear Puller

Working Range: 25-185 MM

Set includes: Twin &  
Triple Leg Heads  
Hydraulic Ram (12 Ton capacity)  
Carbon Steel Beam  
200 MM, 150 MM, & 100 MM arms  
85 MM, 35 MM, Spacers,  
25 MM Centre Adapter



**\$589**  
PN: GHPK

## Rivet & Nutsert Tool

A 2-in-1 fastening tool that sets nutserts as well as blind rivets.



- Sets steel & aluminium rivets up to 4.8 mm & Nutserts up to M6
- Sets stainless rivets up to 4.0 mm & Nutserts up to M5
- Includes a range of M3 to M6 nutserts

**INCLUDES NUTSERTS!**



**\$139**

PN: GHTJ703A

Sets 2.4, 3.2, 4.0 & 4.8 mm Rivets AND M3, M4, M5 & M6 Nutserts

## Heavy Duty Rivet & Nutsert Tool

- Sets steel & aluminium rivets up to 6.4 mm (1/4") AND nutserts up to M10
- Sets stainless steel rivets up to 4.8 mm (3/16") AND nutserts up to M8
- Space-Saving Foldable Handles
- Forged Main Arms



Sets 3.2 (1/8"), 4.0 (5/32"), 4.8 (3/16") & 6.4 mm (1/4") Rivets and M4, M5, M6, M8 & M10 Nutserts

**\$259**

PN: GHTH3

## Riveting Tools

### Medium Duty Riveting Tool

- Sets steel & aluminium rivets up to 4.8 mm (3/16")
- Sets Stainless Steel Rivets up to 4.0 mm (5/32")

Sets 2.4 (3/32"), 3.2 (1/8"), 4.0 (5/32") & 4.8 mm (3/16") rivets



**\$59**

PN: GHTJ701

### Heavy Duty Riveting Tool

- Sets steel, aluminium & stainless rivets up to 4.8 mm (3/16")

Sets 2.4 (3/32"), 3.2 (1/8"), 4.0 (5/32") & 4.8 mm (3/16") rivets



**\$119**

PN: GHTTC20

## Hex Key Sets

### Metric 9 Piece Ball End Hex Key Set

Sizes: 1.5, 2, 2.5, 3, 4, 5, 6, 8 & 10 mm

### Imperial (SAE) 13 Piece Ball End Hex Key Set

Sizes: 0.05", 1/16", 5/64", 3/32", 7/64", 1/8", 9/64", 5/32", 3/16", 7/32", 1/4", 5/16" & 3/8"

### 13 Piece Torx® Wrench Set

Sizes: T6, T7, T8, T9, T10, T15, T20, T25, T27, T30, T40, T45 & T50

### 13 Piece Tamperproof Torx® Wrench Set

Sizes: T6H, T7H, T8H, T9H, T10H, T15H, T20H, T25H, T27H, T30H, T40H, T45H & T50H



**\$41**

PN: GXHK9M

**\$50**

PN: GXHK13

**\$52**

PN: GXTX13

**\$52**

PN: GXTP13

## Pistol Grip Nutsert Tools

- Average cycle time of 3 seconds
- Quick & simple to operate
- Fwd. / Rev. Toggle Switch
- Not suitable for mass production

**POWERED FORWARD + REVERSE**

### M6 Nutsert Tool

M3, M4, M5, M8 & M10 mandrels available (sold separately)  
Weight: 1.3 kg

**\$789**

PN: GP400B

### M8 Nutsert Tool

M10 & M12 mandrels available (sold separately)  
Weight: 1.3 kg

**\$799**

PN: GP200B



## Steel & Aluminium Nutserts

4 mm Max. sheet thickness



**PACKS OF 50**

M4 Aluminium PN: NM4RNA	<b>\$35</b>	M4 Steel PN: NM4PNS	<b>\$19</b>
M5 Aluminium PN: NM5RNA	<b>\$39</b>	M5 Steel PN: NM5PNS	<b>\$25</b>
M6 Aluminium PN: NM6RNA	<b>\$46</b>	M6 Steel PN: NM6PNS	<b>\$29</b>
M8 Aluminium PN: NM8RNA	<b>\$49</b>	M8 Steel PN: NM8PNS	<b>\$32</b>
M10 Aluminium PN: NM10RNA	<b>\$59</b>	M10 Steel PN: NM10PNS	<b>\$39</b>
		M12 Steel PN: NM12PNS	<b>\$65</b>

## Automotive Nutsert Gun

- Sets M4, M5, M6, M8, M10 nutserts in steel & aluminium
- Sets Stainless Steel nutserts up to M8
- Optional M3 anvil set
- Not suitable mass production applications

Traction Power: 3,640 Ft/lbs  
Stroke: 6 mm  
Weight: 1.55 kg



**HOT PRICE!**

**\$1189**

PN: KP4258

# NICRON®

## LED TORCHES & HEADLAMPS

[nicronlight.com.au](http://nicronlight.com.au)

### TWIST Light

The head of a Twist Light can be swiveled anywhere from 0 to 90 degrees, offering extreme versatility.

Applicable to PN: B73R, B71pro, B75 & B70PLUS



### Mini Twin-Beam Headlamp



Brightness: 700 Lm  
Intensity: 4000 Cd

**\$89**  
PN: H11

- High-quality anodised aluminium body
- Primary Beam:
  - LOW (50Lm)
  - MED (250Lm)
  - HIGH (500Lm)
- Flood Light:
  - LOW (35Lm)
  - HIGH (100Lm)
- Weight: 59g

### Mini Rechargeable Headlamp



Brightness: 500 Lm  
Intensity: 160 Cd

**\$69**  
PN: H17

- Anodised aluminium body
- Angle head vertically up to 180°
- USB-C Charge Port
- Weight: 42g

### High Performance Pocket Flashlight

**NEW!**

**\$99**  
PN: C1

Ingress Rating <b>IPX8</b> 2m	Battery Indicator 10% 100%
Two-Way Pen Clip	Magnetic Base
Battery 1 x 16340 Li-ion	



**65 mm Long**  
**Super Bright 1200 Lm!**

- Illuminated Multi-function Switch with Battery State Indicator

Brightness: 1200 Lm  
Intensity: 5500 Cd

Primary Beam:
 

- LOW (25Lm)
- MED (70Lm)
- HIGH (200Lm)
- MAX (1200Lm)
- STROBE: (1200Lm)

 Size: 65 x 20 mm  
Weight: 45g

Battery 1 x 14500 Li-ion	Ingress Rating SPLASH IP65	Charge Port USB TYPE C
-----------------------------	----------------------------------	---------------------------

Battery 1 x 14500 Li-ion	Ingress Rating IPX5	Charge Port USB TYPE C
-----------------------------	------------------------	---------------------------

### TWIST Pen Light

**HOT PRICE!**

**\$69**  
PN: B73R



- Includes USB rechargeable battery
- Illuminated Multi-function Switch with Battery State Indicator

Brightness: 150 Lm  
Intensity: 650 Cd

Primary Beam:
 

- LOW (60Lm)
- HIGH (150Lm)

Size: 152 x 18 x 15 mm  
Weight: 75g

Battery 10840 Li-ion 2 x AAA	Ingress Rating SPLASH IP65	Mag Base	Pen Clip
------------------------------------	----------------------------------	----------	----------

### Twin-Beam Headlamp

- Anti-slip belt for mounting directly to helmets.
- Both lamps combined output 1600 Lm
- Headlamp vertical range of motion 120°
- Includes li-ion battery
- Weight: 69g



Primary Beam:
 

- LOW (50Lm)
- MED (250Lm)
- HIGH (500Lm)
- MAX (1000Lm)

 Flood Light:
 

- LOW (50Lm)
- MED (200Lm)
- HIGH (400Lm)
- MAX (800Lm)

**\$129**  
PN: H35

Brightness: 1600 Lm  
Intensity: 4000 Cd

Battery 1 x 18650 Li-ion	Ingress Rating SPLASH IP65	Charge Port USB TYPE C
-----------------------------	----------------------------------	---------------------------

### PRO TWIST Light



- Illuminated Multi-function Switch with Battery State Indicator
- Pen Clip

Brightness: 950 Lm  
Intensity: 10000 Cd

Primary Beam:
 

- LOW (10Lm)
- MED (70Lm)
- HIGH (300Lm)
- MAX (950Lm)
- STROBE (950Lm)

Size: 160 x 28 mm  
Weight: 220g

**\$99**  
PN: B71pro

Battery 1 x 18650 Li-ion	Ingress Rating SPLASH IP65	Charge Port USB TYPE C	Battery Indicator 10% 100%
Beam Modes	Magnetic Base	Pen Clip	

### UV PRO TWIST Light



- Illuminated Multi-function Switch with Battery State Indicator
- Pen Clip

Brightness: 1000 Lm  
Intensity: 3000 Cd

Primary Beam:
 

- LOW (100Lm)
- MED (500Lm)
- HIGH (1000Lm)

 UV Light:
 

- HIGH (395nm)

Size: 160 x 28 mm  
Weight: 220g

**\$119**  
PN: B75

Battery 1 x 18650 Li-ion	Ingress Rating SPLASH IP65	Charge Port USB TYPE C	Battery Indicator 10% 100%
Beam Modes	Magnetic Base	Pen Clip	
Wt 395 nm			

### Camo TWIST Light



- Illuminated Multi-function Switch with Battery State Indicator
- Pen Clip

Brightness: 950 Lm  
Intensity: 10000 Cd

Primary Beam:
 

- LOW (10Lm)
- MED (70Lm)
- HIGH (300Lm)
- MAX (950Lm)
- STROBE (950Lm)

Size: 160 x 28 mm  
Weight: 220g

**\$119**  
PN: B70PLUS

Battery 1 x 18650 Li-ion	Ingress Rating SPLASH IP65	Charge Port USB TYPE C	Battery Indicator 10% 100%
Beam Modes	Magnetic Base	Pen Clip	



## Magnetic Base

Mount to any ferrous surface. Ideal for wheel wells and engine bays or other tight spaces.

Applicable to PN: B70PLUS, B71pro, B73R, B74BLUE, B74RED, B75, WL15, WL81-83-85



## Integrated Battery Indicator

A dedicated built-in LED battery indicator. Applicable to PN: B400 & WL83



## Multifunction Indicator Button

Illuminated multi-function switch with Battery State Indicator. Displays battery state with back-lit multi-colour LED button.

Applicable to PN: B200, B73R, B71pro, B75 & B70PLUS & WL81



## Dual Fuel Capability

Able to accept high capacity rechargeable and standard A series batteries.

Applicable to PN: B73R, B74BLUE, B74RED & F51



## Integrated Charging Port

Recharge without the need to remove the battery with an integrated charge port.

Applicable to PN: B10, B200, B400, B71PRO, B75, B70PLUS, F81, H11, H17, H35, WL15, WL81-83-85

## Long Range Tactical Flashlight

**\$179**  
PN: B200



**Upgraded Model!**

**1000m RANGE!**

Brightness: 1,600 Lm  
Intensity: 250,000 Cd

Primary Beam:  
**LOW** (100Lm)  
**MED** (750Lm)  
**HIGH** (1600Lm)  
**STROBE:** (1000Lm)  
Size: 235 x 59 mm  
Weight: 550g

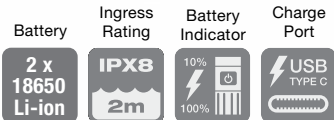

## Extreme Tactical Flashlight

**\$489**  
PN: B400



**Upgraded Model!**

- Flood & Spot functions
- Fast Charging Li-ion
- Beam proximity sensor
- USB-A power bank functionality

Brightness: 16,000 Lm  
Intensity: 19,3600 Cd

Primary Beam:  
**LOW** (7Lm)  
**MED** (170Lm)  
**HIGH** (3,450Lm)  
**MAX** (12,300Lm)  
**EXTREME** (16,000Lm)  
**STROBE:** (6,000Lm)  
Size: 175 x 82 mm  
Weight: 880g

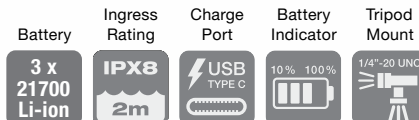

## Mini Flashlight

**\$39**  
PN: B10



Brightness: 200 Lm  
Intensity: 2000 Cd

Primary Beam:  
**LOW** (30Lm)  
**MED** (100Lm)  
**HIGH** (200Lm)  
**STROBE:** (200Lm)  
Size: 65x 20mm  
Weight: 45g

- High Capacity Li-ion Rechargeable
- Key Ring

## Mini Key Chain Flashlight

**\$49**  
PN: N1pro



- 24 hour battery life
- Two-Way Pen Clip
- Magnetic Base

Brightness: 1000 Lm  
Intensity: 1440 Cd

Primary Beam:  
**LOW** (120Lm)  
**MED** (400Lm)  
**HIGH** (1000Lm)  
**STROBE:** (1000Lm)  
Size: 85 x 16 mm  
Weight: 34 g

## Utility Flashlight

**\$65**  
PN: WL15



Brightness: 500 Lm  
Intensity: 800 Cd

Primary Beam:  
**LOW** (80Lm)  
**HIGH** (200Lm)  
Flood Light:  
**LOW** (100Lm)  
**MED** (300Lm)  
**HIGH** (500Lm)

Size: 164 x 22 mm  
Weight: 140g

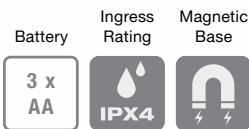

## 2 in 1 Utility Work Lamp

**\$119**  
PN: WL83



- Top mounted hanger
- Top mounted spot light
- Front mounted flood light
- Handle incorporates foldout stand

Brightness: 500 / 200 Lm  
Intensity: 225 Cd

Primary Beam:  
**LOW** (200Lm)  
**HIGH** (500Lm)  
Spot Light:  
**LOW** (200Lm)

Size: 200 x 60 x 30 mm  
Weight: 285g

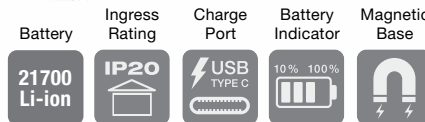

## Mini Focusable Flashlight

**\$89**  
PN: F51



- Focusable Beam
- Includes USB rechargeable battery
- AA batteries NOT included
- Pen Clip

Brightness: 600 Lm  
Intensity: 3800 Cd

Primary Beam:  
**LOW** (100 Lm)  
**MED** (250 Lm)  
**HIGH** (600 Lm)  
Size: 103 x 26 mm  
Weight: 80g

## Utility Flashlight

**\$119**  
PN: WL81



Brightness: 1000 Lm  
Intensity: 6000 Cd

Primary Beam:  
**LOW** (80Lm)  
**MED** (500Lm)  
**HIGH** (1000Lm)  
**STROBE:** (1000Lm)  
Flood Light:  
**LOW** (35Lm)  
**HIGH** (250Lm)  
Size: 121 x 27 mm  
Weight: 110g

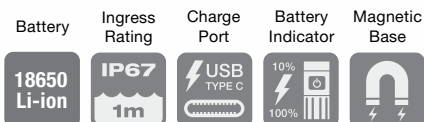

## 2 in 1 Utility Work Lamp

**\$89**  
PN: WL85



**HOT PRICE!**

- Foldout stand with integrated hook
- Primary Beam:  
**LOW** (12 Lm)  
**MED** (160 Lm)  
**HIGH** (450 Lm)  
Spot Light:  
**LOW** (60 Lm)  
**HIGH** (280 Lm)

Size: 123 x 55 x 32 mm  
Weight: 180 g

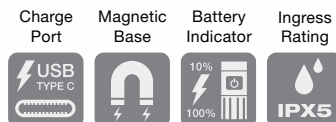

## Focusable Flashlight

**\$119**  
PN: F81



Brightness: 1000 Lm  
Intensity: 6500 Cd

Primary Beam:  
**LOW** (50Lm)  
**MED** (150Lm)  
**HIGH** (500Lm)  
**MAX** (1000Lm)  
**STROBE** (1000Lm)  
Size: 170 x 35mm  
Weight: 200g



## Air-Hydraulic Riveters

### 3/16" Automotive Rivet Gun



Rivet Capacity: 3/32, 1/8, 5/32, 3/16"  
Traction Power: 1950 lbs  
Weight: 1.5 kg

**HOT PRICE!**  
**Only While Stocks Last!**

**\$259**  
PN: GP1121D

### 3/16" Industrial Rivet Gun



Rivet Capacity:  
1/8, 5/32 & 3/16"  
Traction Power: 1980 lbs  
Weight: 1.45 kg

**\$399**  
PN: GP6302

### 9/32" Industrial Rivet Gun



**SUITABLE FOR STAINLESS RIVETS!**

- Interchangeable nose-pieces
- Safety cap collects spent rivets
- Swivel inlet for easier positioning

Rivet Capacity: 3/16", 1/4", 5/32" & 9/32"  
Traction Power: 3,120 lbs  
Weight: 3.4 kg

**\$799**  
PN: GP6304

## Die Grinders

### 1/4" Medium Die Grinder

Free Speed: 22,000 RPM  
Weight: 0.675 kg



**\$99**  
PN: GP2202

### 1/4" Medium Die Grinder

- Polymer sleeved for comfort
- Free Speed: 21,000 RPM  
Weight: 0.833 kg



**\$129**  
PN: GP2202R

### 1/4" Medium Die Grinder Kit

- Kit includes 1/8" & 1/4" collets and a range of 10 grinding stones



Free Speed:  
22,000 RPM

**\$129**  
PN: GP2202K

### 1/4" Angle Die Grinder

Free Speed: 18,000 RPM  
Weight: 0.833 kg



**\$199**  
PN: GP2203R

## Reversible Drills

### Reversible 3/8" Drill

Free Speed: 1,800 RPM  
Chuck Size: 10 mm  
Weight: 1.36 kg



**\$189**  
PN: GP41013

### Reversible 3/8" Keyless Drill

Free Speed: 1,800 RPM  
Chuck Size: 10 mm  
Weight: 1.36 kg



**\$210**  
PN: GP41013K

### 1/2" Reversible Drill

Free Speed: 800 RPM  
Drilling Capacity: 13 mm  
Weight: 1.76kg



**\$269**  
PN: GP4204

### 3/8" Reversible Angle Drill

- Forward / Reverse Toggle Switch
- Rear exhaust

Free Speed: 1500 RPM  
Capacity: 10 mm  
Weight: 1.02kg



**\$299**  
PN: GP4209

## Impact Wrenches

### 1/2" Impact Wrench

Max Torque: 500 Ft/lbs  
Weight: 2.0 kg



**\$299**  
PN: GP260T

### 3/4" Impact Wrench

Max Torque: 1100 Ft/lbs  
Weight: 3.48 Kg



**\$699**  
PN: GP3125

## Heavy Duty Ratchet Wrenches

- Front exhaust
- Max Torque: 75 ft/lbs  
Free Speed: 200 RPM  
Weight: 1.2 kg



3/8" Drive PN: GP5203  
1/2" Drive PN: GP5204

**\$199 ea**

### 1/2" Drive Impact Socket Sets



**HOT PRICES!**

**\$99 ea**

Full range on page 43.

## Air Body Saw

Free Speed: 10,000 opm  
Capacity: 3 mm mild steel  
Stroke length 9.5 mm



**\$269**

PN: GP9301

## Quality Bi-metal Blades

18 TPI Pack of 5

PN: PT301A18

24 TPI Pack of 5

PN: PT301A24

32 TPI Pack of 5

PN: PT301A32



**\$30 ea**

## Economical Gravity Feed Spray Guns

**\$89 ea**

1.4 mm PN: SG898-14

1.8 mm PN: SG898-18

2.2 mm PN: SG898-22

- Stainless steel nozzle & needle
- Brass cap
- Great atomisation
- High transfer rate

Working Pressure: 15-43 PSI  
Pattern Width: 270 mm  
Fluid Output:  
200-220 mL/min  
Capacity: 600 cc  
Weight: 600 g



• Individual nozzle kits also available

## 6" Dual Action Sander

Pad Size: 150 mm Velcro  
Free Speed: 9,000 RPM  
Orbit Dia.: 7 mm  
Weight: 2.0 Kg



**\$199**

PN: GP1205N

## Sandblasters

### All-In-One Sandblaster

- Light weight all in one design
- Ideal for spot and rust removal on small areas

Nozzle Size: 5.2 mm  
Capacity: 266cc

### Sand Blasting Kit

Includes 3 extra nozzles, hose and tube.  
Siphon feed  
Weight: 0.9 Kg



**\$79**

PN: GPASB100

**\$69**

PN: GP909

## Heavy Duty Angle Grinders

### 4" Heavy Duty Angle Grinder

Spindle: M10 x 1.5  
Free Speed: 11,000 RPM  
Weight: 1.95 kg

**\$359**

PN: GP8102

### 5" Heavy Duty Angle Grinder

Spindle: M14 x 2.0  
Free Speed: 11,000 RPM  
Weight: 1.95 kg

**\$399**

PN: GP31003



## 7" Polisher



Free Speed: 2,500 RPM  
Spindle: Male 5/8-11UNC  
Avg Air Cons.: 12 CFM  
Weight: 2.6 kg

**\$369**

PN: GP1206P

## Surface Preparation

### 10 MM Belt Sander

Belt Size: 10 x 330 MM

**\$289**

PN: GP1264A

### 20 MM Belt Sander

Belt Size: 20 x 520 MM

**\$459**

PN: GP1265A



## Air Rust & Paint Removal Tool Kit (Non-vacuum)

Versatile support handle can be set to any position within it's 180° range.

Kit includes:  
five 105 mm (4 inch) stripping wheels, Spare disc hub & carry case.



**\$735**

PN: GP2001A

## Stripping Wheels

- 1 0.5 mm Straight Wire PN: GPA2001A-1
- 2 0.55 mm Hooked Wire PN: GPA2001A-2
- 3 Abrasive Stripping PN: GPA2001A-5
- 4 Caramel Stripping PN: GPA2001A-4
- 5 0.7mm Hooked Wire PN: GPA2001A-3

**\$49 ea**

### 5" Disc Sander

Includes 3", 4-1/2" & 5" fibre pads, for 22 mm hole abrasives, thread adapter for 50 mm pad & 50 mm abrasive pads  
Spindle Size: 3/8 x 24 UNF  
Free Speed: 16,000 RPM  
Weight: 1.2 Kg

**\$179**

PN: GP1204R



### 7" Sander



**\$369**

PN: GP1206A

Free Speed: 4,500 RPM Avg Air Cons.: 12 CFM  
Spindle: Male 5/8-11UNC Weight: 2.6 kg

### Straight Line Sander

- Takes 70 x 445 mm clip on paper.
- Ideal for flat panel automotive work.

Pad Size: 397 x 68 mm  
Free Speed: 2,500 RPM  
Weight: 2.5 Kg

**\$259**

PN: GP1203



## Tyre Inflators

### Dual Tyre Chuck

Inlet: JIS standard fitting  
Output: Schrader Valve



**\$20**  
PN: GPA051

### Flexible Tyre Chuck

Inlet: JIS standard fitting  
Output: Schrader Valve



**\$23**  
PN: GPATC-2

### 0-60psi Tyre Pressure Gauge

Range: 0-60 PSI.  
Metering: Analogue  
Units: PSI & Bar  
Output: Schrader valve



**\$42**  
PN: GPATPG60

### Dual Access Tyre Chuck

Inlet: 1/4" Female  
Output: Schrader Valve x 2  
Length: 220 mm



**\$39**  
PN: GPA1570

### Dual Access Tyre Water Chuck

Inlet: 15 mm male garden hose fitting  
Output: Schrader Valve x 2  
Length: 220 mm



**\$39**  
PN: GPA1570W

### Pistol Grip Tyre Inflator

- Large easy to read gauge
- Integrated purge valve
- Tyre chuck with locking lever



**\$90**  
PN: GPA016

Range: 0-220 PSI  
Metering: Analog  
Units: PSI, Bar, KPA

### Digital Tyre Inflator

Measuring range: 5-60 PSI  
Hose Length: 30 cm  
Units: PSI, Bar, kPa



**\$159**  
PN: GP1558-4

### Deluxe Tyre Inflator

Range: 0-160 PSI  
Units: PSI, KPA



**\$149**  
PN: GPA6200

## Blowguns

### Long Nose Air Duster

- Cast aluminium body, metal trigger & nozzle.

Inlet: 1/4" Nitto fitting  
Nozzle size: 4.5 x 70 mm



**ALL METAL BODY!**

**\$29**  
PN: GPA9025

### 3/8" High Flow Blow Gun Kit

Kit includes:  
High Flow Duster,  
Easily Adjustable High Flow Nozzle, Heavy Duty High Flow Nozzle & Standard Nozzle.



**ALL METAL BODY!**

**\$69**  
PN: GHF60AS

### Integrated Blow Gun

- Light weight Polymer body with 1/4" steel inlet & 2 metre fitted hose



**\$69**  
PN: GPB90K

### Pocket Blow Gun

- Integrated metal inlet thread
  - Rubber Tip
- Length: 115 MM  
Inlet: JIS Fitting  
Material: Aluminium



**\$10**  
PN: PBG-N

**HOT PRICE! Only While Stocks Last!**

### 4" Rubber Tipped Blowgun

- Integrated metal inlet thread
  - Rubber Tip
- Length: 110 mm  
Material: POM/Steel



**\$20**  
PN: GP1562

### Extendable Blow Gun

Length: 270 to 390 mm  
Material: POM/Steel



- Metal inlet for increased durability
- Adjustable length & angle
- Locking ring



**\$36**  
PN: GP1562E

### 1 Metre Blow Gun

Overall Length: 1050 mm  
Inlet: 1/4" metal  
Material: POM / Aluminum

- Durable all metal construction
- Foam grip



**ALL METAL BODY!**

**\$79**  
PN: GP1561

### Filter Cleaning Nozzle

Suitable for cleaning cylindrical filters or pipes.  
SOLD SEPARATELY  
Size: 15.5 dia. x 40 mm  
Nozzles: 12 x 2mm



**\$29**  
PN: GP1561FN

## Wonder Gun Kit

- Quickly change between vacuum & blow with an integrated switch
- Heavy duty metal body

Kit includes: Blow Gun, Vacuum Hose, brush, extended small & flat nozzles, Extendable Hose (30 to 80cm) & Dust Bag



**\$129**  
PN: GPA0310KB



## Punch & Flange Tool

Capacity: 1.2 mm Mild Steel  
Flange Capacity: 14 mm  
Hole Punch Diameter: 5 mm  
Weight : 1.1kg

**\$269**  
PN: GP9201



## 3" In-Line Cut Off Grinder

- Includes 3" cut off disc.
- Adjustable guard
- Spindle lock
- Rubber grip
- Rear exhaust

**\$239**  
PN: GP3203

Disc Size: 3" (75 mm)  
Free Speed: 18,000 RPM  
Weight: 0.8 Kg



## 3" Cut Off Grinder

**\$139**  
PN: GP3201



Disc Size: 3" (75 mm)  
Free Speed: 22,000 RPM  
Weight: 0.8 Kg

## Engine Cleaner Gun

- Siphon type, designed to connect to an external degreaser supply
- Flow rate control with adjustable nozzle
- 1.2m hose with built in filter

Length: 405 mm



**\$59**  
PN: GPA1565

## Engine Cleaner with Bowl

- Ideal for cleaning cars, trucks, bikes and marine

Bowl capacity: 700 cc  
Length: 410 mm



**\$110**  
PN: GPA034

## Percussive Engraving Stylus

- Medium point stylus included
- Fine & wide point stylus also available

Inlet: 1/4" Male thread  
Hose Length: 1.43 m  
Weight: 0.40 kg

**\$329**  
PN: GP110



## Hammering Tools

### Air Hammer Kit

Kit includes 5 Chisels, Spring Retainer, Oiler & Case.  
Free Speed: 3,000 BPM  
Stroke Length: 19.05 mm  
Shank Size: 10.2 mm  
Weight: 1.70 kg

**\$139**  
PN: GP102KD



### Heavy Duty Air Hammer

- Includes 5 chisels & spring retainer

Impact Rate: 2,200 BPM  
Shank Size : 10.2 mm (round)  
Stroke Length : 92 mm  
Weight : 2.05 Kg

**\$189**  
PN: GP112K



## 1/8" Micro Die Grinder Kit

Free Speed: 55,000 RPM

**INCLUDES  
10 GRINDING  
STONES**

**\$249**  
PN: GP2204K



### Set of 2 Spring Retainers

- Suits 10.2 mm round chisels



**\$19**  
PN: GPA70X2

### Heavy Duty Quick Change Spring Retainer

- Fits most standard air hammers & chisels



**\$39**  
PN: GPA2311

### 38 MM Flattening Hammer



**\$59**  
PN: HAC-100

### Needle Scaler Attachment

- Mounts to most standard air hammers
- Replacement needles available



Needle Array: 19 Needles  
Needle size: 3 x 180 mm

**\$110**  
PN: GP60012

### 7" Chisel Set

- 5 piece set includes 20 mm Cold Chisel, Single Blade Cutter, Tapered Punch, Panel Cutter & Rivet Cutter

Shank Dia.: 10.2 mm



**\$59**  
PN: GPA57

## Needle Scaler

### Needle Scaler

- Two part construction for fast dismantling and replacement of worn needles
- Nineteen 3 x 180 mm needles

Stroke Length : 33 mm  
Impact Rate: 4,600 BPM  
Length: 420 mm  
Weight: 2.8 kg



**\$399**  
PN: GP201

### Needle Scaler Kit

- Includes Moil Point, 20 mm Flat, 35 mm Bents & Needle Scaler Attachment in plastic carry case

Impact Rate : 4600 BPM  
Overall length : 460 mm  
Piston Stroke : 38 mm  
Weight : 2.1 Kg



**\$499**  
PN: GP268K

## Compact Needle Scaler



Impact Rate: 3,700 BPM  
Overall Length: 290 MM  
12 Needles Ø3 x 125 MM

**\$299**

PN: KP4714

## Heavy Duty Chipping Hammer

- Moil Point & Flat Chisels available
- Side Exhaust

Includes  
**2**  
Chisels



Stroke: 102 MM  
Impact Rate: 1500 BPM  
Length: 350 MM  
Weight: 9 Kg

**\$969**

PN: KP4735S3H

## Two Speed Pistol Grip Sander

- Includes 50 MM & 75 MM Quick-Lock Backing Pads
- Side mounted speed regulator



Free Speed: 15,000 RPM  
Weight: 0.45 Kg

**\$199**

PN: KP6712

## 1/2" Impact Wrench

Max Torque  
**1,000**  
Ft/lbs



Free Speed: 9,500 RPM  
Max Torque: 1,000 Ft/lbs  
Weight 2.30 Kg

**\$369**

PN: KP1488

## 3/4" Impact Wrench

Free Speed: 5,500 RPM  
Max Torque: 1,100 Ft/lbs  
Weight: 6.1 Kg

**\$999**

PN: KP1030

## 3/4" Impact Wrench with 6" Extension

Free Speed: 5,500 RPM  
Max Torque: 1,050 Ft/lbs  
Weight: 6.85 Kg

**\$1239**

PN: KP1030-6

## Pistol Grip Needle Scaler



Impact Rate: 3,700 BPM  
Overall Length: 350 MM  
19 Needles Ø3 x 180 MM

**\$449**

PN: KP4722P

## Pittsburgh Air Hammer

- 360° Adjustable Anvil Guide

Impact Rate: 4,200 RPM  
Stroke: 50 MM  
Weight: 2.20 Kg



**\$299**

PN: KP4711PH

## 3" Orbital Pistol Grip Sander

- Side mounted speed regulator

Free Speed: 15,000 RPM  
Weight: 0.58 Kg



**\$269**

PN: KP6628

## 1" Super Duty Impact Wrench

Free Speed: 5,000 RPM  
Max. Torque: 1,800 Ft/lbs  
Weight: 7.10 Kg

**\$1439**

PN: KP1838A-P

## Through Ratchet Wrench

- Included socket sizes: 8, 10, 12, 13, & 14 MM  
5/16, 3/8, 7/16, 1/2 and 9/16" 1/4" & 3/8" anvils

Includes  
**10**  
Sockets



**HOT PRICE!**

Free Speed: 450 RPM  
Max. Torque: 30 Ft/lbs  
Weight: 0.60 Kg

**\$289**

PN: KP2219

## Heavy Duty Air Caulking Gun



Takes 50 MM diameter sausages  
400, 500 & 600 ml sizes.  
Air pressure: 45-90 PSI  
Length: 550 MM  
Weight: 0.9 Kg

**\$339**

PN: KP4613

## Dual Chuck Tyre Inflator

Units: PSI, kg/cm2, KPA & Bar  
Air Flow: 1.28 CFM @ 100 PSI  
Range: 0-220 PSI  
Hose Length: 750 MM  
Weight: 1.2 Kg

Ideal for  
**Truck Tyres**

**HOT PRICE!**



**\$149**

PN: KP79G07

## 1" Super Duty Impact Wrenches

Free Speed: 5,500 RPM  
Max. Torque: 1,600 Ft/lbs  
Air Inlet: 1/2"

Length: 325 MM  
Weight: 5.8 Kg



**\$1339**

PN: KP1835

## 3/4" Impact Wrench

Free Speed: 5,500 RPM  
Max Torque: 1,100 Ft/lbs  
Weight: 6.1 Kg

**\$999**

PN: KP1030

## 3/4" Impact Wrench with 6" Extension

Free Speed: 5,500 RPM  
Max Torque: 1,050 Ft/lbs  
Weight: 6.85 Kg

**\$1239**

PN: KP1030-6

## 1" HD Impact Wrench

- Rubber body protection
- 4 power settings with forward & reverse selector
- Side handle

Free Speed: 3,500 RPM  
Max. Torque: 2,500 Ft/lbs  
Length: 436 MM  
Air Inlet: 1/2"  
Weight: 15.55 Kg

**2,500**  
Ft/lbs



**\$2679**

PN: KP1045

1.5" Variant  
PN: KP1050 \$2999

Great for  
**Truck Shops!**

## SG420 Gravity Feed Air Brush



**\$149**  
PN: SG420A

Nozzle: 0.2 MM  
Working Pressure: 14-50 PSI  
Fluid Capacity: 7 cc  
Weight: 280 g

## KH818 Gravity Feed Spray Guns



**\$285 ea**

- Forged aluminum body and Stainless steel nozzle & needle
- Teflon seals & packing

Working Pressure: 30-45 PSI  
Fluid Capacity: 600 cc  
Weight: 280 g

**1.3 MM Nozzle PN: K818M13**  
**1.4 MM Nozzle PN: K818M14**  
**1.8 MM Nozzle PN: K818M18**  
**2.5 MM Nozzle PN: K818M25**

## KH818 HVLP Gravity Feed Spray Guns



**\$299 ea**

- Forged aluminum body and Stainless steel nozzle & needle
- HVLP nozzle delivers exceptional fluid atomization.
- Teflon seals & packing.
- Includes mini air regulator

Working Pressure: 20-28 PSI  
Fluid Capacity: 600 cc  
Weight: 514 g

**1.3 MM Nozzle PN: KH818M13**  
**1.4 MM Nozzle PN: KH818M14**  
**1.8 MM Nozzle PN: KH818M18**

## K818 Suction Feed Spray Guns



**\$289 ea**

- Forged aluminum body and Stainless steel nozzle & needle
- Teflon seals & packing

Working Pressure: 30-45 PSI  
Fluid Capacity: 1000 cc  
Weight: 514 g

**1.3 MM Nozzle PN: K818S13**  
**1.8 MM Nozzle PN: K818S18**  
**2.0 MM Nozzle PN: K818S20**  
**2.5 MM Nozzle PN: K818S25**

## KH818 HVLP Suction Feed Spray Guns



**\$325**  
PN: KH818S18

- Forged aluminum body & Stainless steel nozzle & needle
- HVLP nozzle delivers exceptional fluid atomization.
- Teflon seals & packing.
- Includes mini air regulator

Working Pressure: 20-28 PSI  
Fluid Capacity: 1000 cc  
Weight: 514 g  
Nozzle: 1.8 MM S-Steel

## K357 Mini Gravity Feed Spray Guns



Working Pressure: 30-45 PSI  
Fluid Capacity: 125 cc  
Weight: 280 g

**0.8 MM Nozzle**

**1.2 MM Nozzle**

**\$215**  
PN: K357M08

**\$245**  
PN: K357M12

## K818 Pressure Feed Spray Gun Systems



### 2 Litre Pressure Feed Spray Gun Systems

Features:

- 3 meter hose
- Tank Pressure Regulator
- Air release valve
- Safety release valve
- Tank handle/hanger

**2 Litre Pressure Feed Tank**

Tank dimensions:  
130L MM x 130W MM x 445H MM  
Capacity: 2 Litre  
Max. pressure: 60 PSI  
Weight total: 2.15 Kg

**1.2 MM Nozzle PN: PW2LTRK12**  
**1.5 MM Nozzle PN: PW2LTRK15**  
**1.8 MM Nozzle PN: PW2LTRK18**  
**2.0 MM Nozzle PN: PW2LTRK20**  
**2.5 MM Nozzle PN: PW2LTRK25**

**\$529 ea**

### 10 Litre Pressure Feed Spray Gun Systems

Features:

- 3 meter hose
- Tank Pressure Regulator
- Air release valve
- Safety release valve
- Tank handle/hanger

**10 Litre Pressure Feed Tank**

Tank dimensions:  
315L MM x 315W MM x 485H MM  
Capacity: 10 Litre  
Max. pressure: 60 PSI  
Weight total: 10.1 Kg

**1.2 MM Nozzle PN: PW10LTRK12**  
**1.5 MM Nozzle PN: PW10LTRK15**  
**1.8 MM Nozzle PN: PW10LTRK18**  
**2.0 MM Nozzle PN: PW10LTRK20**  
**2.5 MM Nozzle PN: PW10LTRK25**

**\$685 ea**

### 20 Litre Pressure Feed Spray Tank Systems

Features:

- 10 meter hose
- Stainless Steel Liner
- Tank Pressure Regulator
- Air release valve
- Safety release valve
- Manual Agitation

**K818 Pressure Feed 20 Litre Pressure Feed Tank**

Tank dimensions:  
400L MM x 400W MM x 780H MM  
Capacity: 20 Litre  
Max. pressure: 60 PSI  
Weight total: 26 Kg

**1.2 MM Nozzle PN: PW20LTRK12**  
**1.5 MM Nozzle PN: PW20LTRK15**  
**1.8 MM Nozzle PN: PW20LTRK18**  
**2.0 MM Nozzle PN: PW20LTRK20**  
**2.5 MM Nozzle PN: PW20LTRK25**

**\$1199 ea**

## 1/2" Twin Hammer Impact Wrench



- Light weight composite housing
- 4 speed air regulator
- Exhausts through handle, away from the work area

Free Speed: 8,000 RPM  
Max Torque: 685 Ft/lbs (928 Nm)  
Weight: 1.98kg

**\$399**

PN: BIT260M1

## 6" Random Orbital Sander



Orbit Diameter: 5 mm  
Spindle: 5/16"x24 UNF  
Free Speed: 12,000 RPM  
Weight: 0.99 Kg

**\$289**

PN: BOS156A2

## 6" Random Orbital Dust-Free Sander



Orbit Diameter: 5 mm  
Free Speed: 12,000 RPM  
Spindle: 5/16 x 24 UNF  
Weight: 0.99 kg

**\$299**

PN: BOS156SA2

## 1/4" Die Grinder

Free Speed: 20,000 RPM  
Length: 165 mm  
Weight : 0.55Kg



**\$189**

PN: BG210R

## 1/4" 115° Angle Die Grinder

Free Speed: 18,000 RPM  
Output: 0.45 hp  
Weight : 0.75 Kg



**\$229**

PN: BG230RA1

## 1/4" Right Angle Die Grinder

- Light weight composite housing

Free Speed: 18,000 RPM  
Length: 183 mm  
Weight: 0.8 Kg



**\$199**

PN: BG220RA1

## Extended 1/4" Die Grinder

Free Speed: 21,000 RPM  
Length: 280 mm  
Weight: 0.80 Kg



**\$199**

PN: BG215RA1

## 2" Angle Grinder

Free Speed: 15,000 RPM  
Output : 0.45 hp  
Weight: 0.8 Kg



**\$199**

PN: BG222RA1

2" Grinder Disc  
Thickness: 4 mm  
Max Speed: 23,500 RPM



**\$13**

PN: 3510232

## 8" Geared Sanders

Orbit Diameter: 5 mm  
Pad mount: 5 hole  
Free Speed: 900 RPM  
Weight: 1.88 kg



Standard  
**\$579**

PN: BOS258GR-D1

Dust Free  
**\$589**

PN: BOS258GRC-D1

## 1/2" Reversible Keyless Drill



Free speed: 800 RPM  
Weight: 1.95 Kg

**\$249**

PN: BDR208KLA1

**HOT PRICE!**  
Only While Stocks Last!

## Heavy Duty Air Hammer Kit

- Integrated piston cushion for lower vibration and less operator fatigue
- T handle design for better tool balance
- Includes Air Hammer, 5 chisels & Quick Change Spring Retainer in blow-mount case

Impact Rate: 2,900 bpm  
Chisel shank: 10.2 mm  
Weight: 1.73 Kg

**\$289**

PN: BHA67A1



## 3" Cut Off Tool



Free Speed: 21,000 RPM  
Length: 188 mm  
Weight: 0.8 Kg

Cutting Disc not included.

**\$149**

PN: BCTA1

## 3" Cutting Discs

Ø75 x 0.8 x Ø9.53 mm  
Speed Rated to 25,000 RPM



Pack of 5

**\$29**

PN: CO007K

## 80 Series Stapler

Staple Crown: 12.8 mm  
(80 Series)  
Staple Length: 6-16 mm  
Capacity: 100 Staples  
Weight: 0.90 Kg



**\$199**

PN: BN8016E

## Countersink & Nail Remover

Pin Dia.: 4.8 mm  
Nail Dia.: 2-4 mm  
Weight: 0.80 Kg



**\$349**

PN: BPULLER

**GREAT FOR  
TIMBER FRAME  
DEMOLITION!**

**REMOVE  
ASBESTOS SHEETS  
IN ONE PIECE!**

## C1 Series Bradder

Shank: 1x1.25 mm  
(18 Gauge)  
Nail Length: 10-32 mm  
Capacity: 100 brads  
Weight: 0.68 Kg



**\$199**

PN: B1832PA2

## Medium Duty C Brad Nailer

Shank: 1.4x1.6 mm  
(16 Gauge)  
Nail Length: 19-50 mm  
Capacity: 100 brads  
Weight: 1.54 Kg



**HOT  
PRICE!**

**\$289**

PN: B1650LA1

## 97 Series Stapler

Staple Crown: 4.5 mm  
(97 Series)  
Staple Length: 10-25 mm  
Capacity: 142 staples  
Weight: 1.2Kg



**HOT  
PRICE!**

**\$249**

PN: BS9725B1

## 50 MM C1 Series Bradder

Shank: 1x1.25 mm  
(18 Gauge)  
Nail Length: 15-50 mm  
Capacity: 100 brads  
Weight: 1.25 Kg



**\$259**

PN: B1850A1

## T-Nailers

Nail Length: 18-64 mm  
Capacity: 80 nails  
Weight: 2.55 kg



**HOT  
PRICE!**

**Only While  
Stocks Last!**

2.2 mm Nail Shank  
PN: BT2264A1

2.5 mm Nail Shank  
PN: BT2564A1

**\$389 ea**

## Heavy Duty C Brad Nailer

Shank: 1.4x1.6 mm  
(16 Gauge)  
Nail Length: 19-50 mm  
Capacity: 100 nails  
Weight: 1.9 Kg



**\$399**

PN: B1650B1

## Heavy Duty Coil Nailer

Shank: 2.03-2.8 mm  
Nail Length: 32-65 mm  
Capacity: 200-400 nails  
Weight: 2.3 kg



**HOT  
PRICE!**

**Only While  
Stocks Last!**

0° Angle PN: BC2865F1

15° Angle PN: BC2865D1

**\$489 ea**

## 34° DA Nailer

- Swivel exhaust
- Depth adjustment
- Angled air inlet

Shank:  
1.8 mm (15 gauge)  
Nail Length:  
25-64 mm  
Capacity:  
100 Nails  
Weight: 1.95kg



**HOT  
PRICE!**

**Only While  
Stocks Last!**

**\$369**

PN: BA3464A1

## Premium Compressor Oil

- Specially formulated additives give superior protection against wear and corrosion
- Excellent water & air separation, to ensure reliable operation with minimal foaming and emulsification



**\$33**

PN: COMPOIL1

## 1/4" Mini Filter Regulator

Max Press.: 280 PSI  
Output Press.: 7-142 PSI  
Units: PSI, kg/cm<sup>2</sup>  
Max Flow: 38.85 CFM  
Drain Capacity: 15 mL  
Filter Element: 5 μm



**\$89**

PN: THBFR212

## 1/4" Mini Filter Regulator & Lubricator

Max Press.: 150 PSI  
Output Press.: 7-142 PSI  
Units: PSI, kg/cm<sup>2</sup>  
Max Flow: 38.85 CFM  
Drain Capacity: 15 mL  
Oil Capacity: 30 mL  
Filter Element: 5 μm



**SUPER COMPACT!**  
140W x 135H mm

**\$89**

PN: THBC202

## Filter Regulators

Max Press.: 215 PSI  
Output Press.: 7-150 PSI  
Units: PSI, kg/cm<sup>2</sup>  
Drain Capacity: 80 mL  
Filter Element: 5 μm

Port Size: 1/4" NPT  
Max Flow: 61.8 CFM

PN: THBFR802

Port Size: 3/8" NPT  
Max Flow: 88.29 CFM

PN: THBFR803

Port Size: 1/2" NPT  
Max Flow: 105.94 CFM

PN: THBFR804



**\$75 ea**

## 3/4" Hi-Flow Filter Regulator

Max Press.: 250 PSI  
Output Press.: 7-142 PSI  
Units: PSI, kg/cm<sup>2</sup>  
Max Flow: 162.45 CFM  
Drain Capacity: 300 mL

PN: THBFR926A

## 1" Hi-Flow Filter Regulator

Max Press.: 250 PSI  
Output Press.: 7-142 PSI  
Units: PSI, kg/cm<sup>2</sup>  
Max Flow: 183.64 CFM  
Drain Capacity: 300 mL

PN: THBFR928A

**\$319 ea**



## Filter Regulator + Lubricators

Max Press.: 215 PSI  
Output Press.: 7-150 PSI  
Units: PSI, kg/cm<sup>2</sup>  
Oil Capacity: 125 mL  
Filter Element: 5 μm

Port Size: 1/4" NPT  
Max Flow: 61.8 CFM

PN: THBFLR802

Port Size: 3/8" NPT  
Max Flow: 88.29 CFM

PN: THBFLR803

Port Size: 1/2" NPT  
Max Flow: 105.94 CFM

PN: THBFLR804



**\$139 ea**

## Regulators



### 1/4" Regulator

Max Press.: 150 PSI  
Output Press.: 7-142 PSI  
Units: PSI, kg/cm<sup>2</sup>  
Max Flow: 38.85 CFM

**\$52**

PN: THBR202

### 1/2" Regulator

Max Press.: 215 PSI  
Output Press.: 7-150 PSI  
Units: PSI, kg/cm<sup>2</sup>  
Max Flow: 105.94 CFM

**\$62**

PN: THBR804

### 3/4" Regulator

Max Press.: 250 PSI  
Output Press.: 7-225 PSI  
Units: PSI, kg/cm<sup>2</sup>  
Max Flow: 162.45 CFM

**\$179**

PN: THBR906

### 1" Regulator

Max Press.: 250 PSI  
Output Press.: 7-225 PSI  
Units: PSI, kg/cm<sup>2</sup>  
Max Flow: 183.64 CFM

**\$179**

PN: THBR908

## Filters

### 1/2" Filter

Port Size: 1/2" NPT  
Max Press.: 215 PSI  
Max Flow: 105.94 CFM



**\$69**

PN: THBF804

### 1/2" Auto Drain Filter

Port Size: 1/2" NPT  
Max Press.: 225 PSI



**\$99**

PN: THBD704A

## Lubricators

Max Press.: 215 PSI  
Oil Capacity: 125 mL

Port Size: 1/4" NPT  
Max Flow: 61.8 CFM

PN: THBL802

Port Size: 3/8" NPT  
Max Flow: 88.29 CFM

PN: THBL803

Port Size: 1/2" NPT  
Max Flow: 105.94 CFM

PN: THBL804

**\$79 ea**



## Filter / Regulator / Dryers

- Includes desiccant

Max Press.: 250 PSI  
Output Press.: 7-150 PSI  
Units: PSI, kg/cm<sup>2</sup>  
Filter Element: 5μ-0.01μ

Port Size: 1/4" NPT  
Max Flow: 61.8 CFM

PN: THBFR-FLM862

Port Size: 3/8" NPT  
Max Flow: 88.29 CFM

PN: THBFR-FLM863

Port Size: 1/2" NPT  
Max Flow: 105.94 CFM

PN: THBFR-FLM864

**\$269 ea**

**IDEAL FOR SPRAY PAINTING!**



Replacement dryer desiccant pack of 2 PN: THBDES \$20

The EziShear range delivers outstanding service life and economical operation through the utilization of replaceable blades and standard bolts and bearings.

Max. Speed: 2400 RPM  
Cutting Capacity:  
Stainless Steel: 1.2 mm  
Mild Steel: 1.6 mm  
Aluminium: 2.2 mm



### Cam-Drive Ezi-Shear

Cam-Drive Ezi-Shear to suit **Milwaukee™**

Milwaukee M18™ 14 Gauge Double Cut Shears (2636-20)  
Milwaukee M18™ 18 Gauge Single Cut Shears (2637-20)  
Milwaukee M18™ Double Cut Shears (2635-20)

**\$259**  
PN: EZISMIL



### Cam-Drive Ezi-Shear

Cam-Drive Ezi-Shear to suit **Makita™**

Makita™ 18V Offset Shear (DJS131Z)  
Makita™ 18V D-Handle Offset Shear (DJS132Z)

**NEW!**

**\$259**  
PN: EZISMAK



### Shaft-Drive Ezi-Shear

Shaft-Drive Ezi-Shear Drill Head:

Fits drills with Metal gearbox with a 43 mm diameter (European standard) neck and at least 15 mm shank

3/8" Drive PN: EZIS038

1/2" Drive PN: EZIS012

**\$259 ea**



### Cam-Drive Ezi-Shear

Cam-Drive Ezi-Shear to suit **Dewalt™**

Dewalt XR™ Metal Shears (DCS491N)

**\$259**  
PN: EZISDEW



### Hex-Drive Ezi-Shear

Hex-Drive Ezi-Shear to suit **FESTOOL™**

FESTOOL DR 18™ QuaDrill Electric Drill 705W (768936)  
FESTOOL DRC 18™ Drill (500782)  
FESTOOL DRC 18™ Drill 18V (500752)  
FESTOOL PDC 18™ Hammer Drill (500781)  
FESTOOL DRC 18™ Drill 5.2Ah (201557)  
Metabo Hammer Drill (SB18LTX BL)

**\$319**  
PN: EZIS014H



### 3/16" Medium Duty Riveter

- Suitable for Aluminium & Mild Steel rivets

Capacity:  
2.4 mm (3/32") to  
4.8 mm (3/16")  
Traction power: 1045 Kg  
Stroke: 16 mm  
Weight: 1.56 Kg



Includes an Assortment of Aluminium Rivets & Spares

**\$269**  
PN: FP4821AK

### 3/16" Compact Riveter with Vacuum Extraction

- Suitable for Aluminium & Mild Steel rivets
- Vacuum Mandrel collection

- Low Recoil Technology

Capacity: 2.4 mm (3/32") to 4.8 mm (3/16")  
Traction power: 908 Kg  
Stroke: 15 mm  
Weight: 1.39 Kg



Ideal for the Aluminium Window Industry

**\$859**  
PN: FP4032CVK

### 3/16" Heavy Duty Composite Riveter

- Suitable rivets of all materials
- Low Recoil Technology

Capacity: 2.4 mm (3/32") to 4.8 mm (3/16")  
Traction power: 908 Kg  
Stroke: 23.5 mm  
Weight: 1.55 Kg

**\$699**  
PN: FP4831C

### 1/4" Riveter with Vacuum Extraction

- Automatic mandrel collection
- Sets steel and stainless ONLY
- Swivel air inlet

Capacity: 4.8mm (3/16"), 5.6mm (7/32") & 6.4mm (1/4")  
Traction power: 1645 Kg  
Stroke: 15 mm  
Weight: 1.8 Kg

**\$739**  
PN: FP6431CVK

### 5/16" Heavy Duty Composite Riveter

- Vacuum mandrel collection
- Suitable rivets of all materials
- Swivel air inlet

Capacity: 3/16", 7/32", 1/4" & 5/16"  
Traction power: 1723 Kg  
Stroke: 22.5 mm  
Weight: 1.8 Kg



Also Sets 1/4" Monobolt® Structural Rivets FP51631CVK ONLY

**\$1279**  
PN: FP51631CVK

## Quick-Lock Backing Pads

Attach abrasive pads to tool. Includes 1/4" shank adapter.

50 MM Quick-Lock Backing Pad

75 MM Quick-Lock Backing Pad

**\$19**

PN: GPA1523K



**\$24**

PN: GPA1524K



## HOT PRICES!

### Quick-lock Abrasive Pads

Packs of 10



50 MM Abrasive Fine

Fine Blue PN: GPA1527X10

75 MM Abrasive Pads

Fine Blue PN: GPA1530X10

Maroon Medium PN: GPA1528X10

Maroon Medium PN: GPA1531X10

Brown Coarse PN: GPA1526X10

Brown Coarse PN: GPA1529X10

**\$32 ea**

**\$49 ea**

### Quick-Lock Ceramic Sanding Discs

Packs of 10



50 MM Quick-Lock Ceramic Sanding Discs

36 Grit PN: AB22012S36CP

60 Grit PN: AB22012S60CP

80 Grit PN: AB22012S80CP

120 Grit PN: AB22012S120CP

75 MM Quick-Lock Ceramic Sanding Discs

36 Grit PN: AB22013S36CP

60 Grit PN: AB22013S60CP

80 Grit PN: AB22013S80CP

120 Grit PN: AB22013S120CP

**\$27 ea**

**\$32 ea**

### Quick-Lock Ceramic Flap Discs

Packs of 5



50 MM Quick-Lock Ceramic Mini Flap Discs

40 Grit PN: AB22012F40CP

60 Grit PN: AB22012F60CP

80 Grit PN: AB22012F80CP

120 Grit PN: AB22012F120CP

75 MM Quick-Lock Ceramic Mini Flap Discs

40 Grit PN: AB22013F40CP

60 Grit PN: AB22013F60CP

80 Grit PN: AB22013F80CP

120 Grit PN: AB22013F120CP

**\$19 ea**

**\$29 ea**

## Quick-Lock Preparation Kits

### 2" Quick-Lock Preparation Kit

7 Piece kit includes: 1/4" shank, 2" backing pad, 24 grit 2" disc, 36 grit 2" disc, 50 grit 2" disc, Brown (Coarse) surface prep 2" disc & Maroon (Medium) surface prep 2" disc.

**\$39**

PN: GPK2



### 3" Quick-Lock Preparation Kit

7 Piece kit includes: 1/4" shank, 3" backing pad, 24 grit 3" disc, 36 grit 3" disc, 50 grit 3" disc, Brown (Coarse) surface prep 3" disc & Maroon (Medium) surface prep 3" disc.

**\$49**

PN: GPK3



Abrasive & Sanding Pads made in USA.

## Ceramic Sanding Belts

Pack of 10 Belts.



10 MM Sanding Belts

Size: 10 mm x 330 mm

40 Grit PN: AB2700-40CP

60 Grit PN: AB2700-60CP

80 Grit PN: AB2700-80CP

120 Grit PN: AB2700-120CP

**\$27 ea**

20 MM Sanding Belts

Size: 20 mm x 520 mm

40 Grit PN: AB2800-40CP

60 Grit PN: AB2800-60CP

80 Grit PN: AB2800-80CP

120 Grit PN: AB2800-120CP

**\$35 ea**

30 MM Sanding Belts

Size: 30 mm x 540 mm

40 Grit PN: AB2830-40CP

60 Grit PN: AB2830-60CP

80 Grit PN: AB2830-80CP

**\$56 ea**

## HOT PRICES!

### Quick-Lock Polishing Pads



50 MM Quick-Lock Felt Polishing Pad

**\$19**

PN: GPA1525



75 MM Quick-Lock Felt Polishing Pad

**\$19**

PN: GPA1575

### Polishing Mops

1/4" Shank Tapered Spindle

Fits 50 MM Calico Polishing Mops (PN: PMC50).

50 MM Calico Polish Mop

For use with Taper Spindle (PN: TS12). Width: 20 MM



**\$53**

PN: TS12



**\$39**

PN: PMC50

### Velcro Backing Pads

50 MM Velcro Backing Pad

Shank Size: 1/4"



**\$39**

PN: GPA50

75 MM Velcro Backing Pad

Shank Size: 1/4"

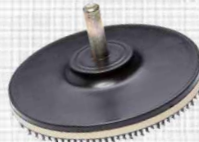

**\$49**

PN: GPA75

### Velcro Polishing Pads

60 MM Polishing Pad

Suits 50 mm Velcro Backing Pad



**\$14**

PN: OWB-60

80 MM Polishing Pad

Suits 75 mm Velcro Backing Pad



**\$24**

PN: 119-102



## 8 Piece Flap Wheel Kit

Kit includes:  
 25 x 12 mm, 120 Grit, x 1  
 40 x 25 mm, 80 Grit, x 1  
 25 x 25 mm, 40 Grit, x 1  
 50 x 25 mm, 80 Grit, x 1  
 25 x 25 mm, 80 Grit, x 1  
 50 x 25 mm, 60 Grit, x 2  
 40 x 25 mm, 60 Grit, x 1



**HOT PRICE!**

**\$49**  
 PN: GFWK

## 125 MM Turbo Backing Pad

• Lock Nut included  
 Pad Thickness: 18 MM  
 Max Speed: 10,000 RPM  
 Thread Size: M14 x 2 Int.



**\$39**

PN: GTP162214

## Cut off Discs



50 MM Discs

Disc Size: 50 x 1 mm  
 Bore: 1/4"  
 Max Speed: 30,000 RPM

75 MM Discs

Disc Size: 75 x 0.8 mm  
 Bore: 9.53 mm  
 Max Speed: 25,000 RPM

Packs of 10

**\$39**

PN: ABPCWHEELS

Packs of 5

**\$29**

PN: CO007K

## Clean & Strip Discs

• Removals of paint & light rust  
 • Will not damage the original surface

10 x 50 MM

**\$15**

PN: ABCH902P

10 x 75 MM

**\$25**

PN: ABCH903P



Packs of 2

## 150 MM Velcro Backing Pads

Spindle Size: 5/16" x 24 UNF Ext.  
 Max Speed: 12,000 RPM  
 Pad Thickness: 10 mm

Velcro Backing Pad



**\$49**

PN: F6505

Dust Free Velcro Backing Pad



**\$49**

PN: F6565

## P2 RESPIRATORS

**MP AUSSIE PRODUCTS**  
JOB DONE

**FLUOR GREEN**  
PN: MPLR-P2FG

**BLACK**  
PN: MPLR-P2B

Compact enough to fit underneath welding helmets.

**AUSTRALIAN MADE**

**Was \$36**  
**Now!**  
**\$26 ea**

**+2 P2 Filters**  
Each respirator comes with 2 additional disposable P2 filters.

**HURRY!**  
Only While Stocks Last!

**flexipads**

WHAT QUALITY FEELS LIKE™

### 180 MM Nylon Backing Pads

• Medium Pad Density  
 Thread Size: M14 x 2 Int.  
 Pad Thickness: 20 MM  
 Max Speed: 8,500 RPM



**\$39**

PN: FP20305

### Heavy Duty 5" TURBO Grinding Pads

**Ultra Tough & Rigid Pads**  
 ideal for grinding!

Thread Size: M14 x 2 Int.  
 Pad Thickness: 18 MM  
 Max Speed: 12,250 RPM



**\$32**

PN: FP11723

### Nylon Backing Pads

#### 100 MM Nylon Backing Pad

• Medium Pad Density  
 Thread Size: M14 x 2 Int.  
 Pad Thickness: 15 MM  
 Max Speed: 12,250 RPM

**\$29**

PN: FP20020

#### 125 MM Nylon Backing Pad

• Medium Pad Density  
 Thread Size: M14 x 2 Int.  
 Pad Thickness: 16 MM  
 Max Speed: 12,250 RPM

**\$29**

PN: FP20210

### 6" Dust Free Multi-Fit Velcro Pad

Thread Size: M8 & 5/16" UNF  
 Pad Thickness: 14 MM  
 Max Speed: 12,000 RPM

**\$89**

PN: FP17099



**Suits Festool & Makita Sanders!**

### Sheep Skin Polishing Bonnets



**100% Merino Sheep Skin Wool!**

Disc Size: 5" (125 MM)  
 Max. speed: 2,500 RPM  
 Thickness: 32 MM

**\$39**

PN: FP40005

## 20m Manual Hose Reel

- High quality Polyurethane braided hose
- Space Saving Foldable Handle
- 360 degree swivel base
- Hose ID: 8 mm
- Hose OD: 12 mm

**\$299**

PN: GPHR1220



## Swivel Connectors

Male thread to Japanese Style Plug  
Range: 22°

1/4" Thread PN: B05

3/8" Thread PN: B07

**\$20 ea**



## In-line Regulators

1/4" Air Flow Regulator

**\$22**

PN: GPA1010



1/4" Air Flow Regulator with Male plug

**\$22**

PN: GPA1011



## Air Line Quick Coupler Manifolds

2 Way Cluster Quick Coupler



**\$39**

PN: GPA1513

3 Way Cluster Quick Coupler



**\$49**

PN: GPA1514

2 Way In-line Quick Coupler



**\$39**

PN: GPA1515

3 Way In-line Quick Coupler



**\$49**

PN: GPA1516

4 Way In-line Quick Coupler



**\$49**

PN: GPA1517

## 20m Wall Mount Hose Reel

- 180° swivel bracket
- 1.5 metre inlet hose
- High quality braided polyurethane hose
- Sheet metal housing
- Adjustable recoil stopper
- Shrouded air line socket
- Hose ID: 6.5 mm
- Hose OD: 10 mm

**\$299**

PN: GPHR1020



## Bare In-line Manifolds

2 Way In-line Bare Manifold

**\$20**

PN: GPATA2

3 Way In-line Bare Manifold

**\$21**

PN: GPATA3

4 Way In-line Bare Manifold

**\$23**

PN: GPATA4



## One-Touch Connector Kits

- Kit includes Hose Clamps, One-Touch Socket & Plug fittings

10mm Kit  
PN: AHPACK

**\$32**

12mm Kit  
PN: AHPACK12

**\$41**



## In-line Components

1/4" In-line Water Separator

1/4" NPT Female to Male



**\$39**

PN: GPA1512

1/4" In-line Lubricator

1/4" NPT Female to Male  
Capacity: 15 mL



**\$30**

PN: GPA1025

## Premium Air Tool

Add only a couple of drops daily to prolong the performance of any air operated tool  
Formulated to greatly reduce internal wear and maintain the integrity of gaskets and seals



250 ML

**\$13**

PN: SI250

1 Litre

**\$27**

PN: SI1000

5 Litre

**\$98**

PN: SI5000

## 10 MM Bare Air Hoses

20m Roll

**\$59**

PN: AH1020

30m Roll

**\$99**

PN: AH1030

100m Roll

**\$279**

PN: AH10100

## 12 MM Bare Air Hoses

20m Roll

**\$99**

PN: AH1220

30m Roll

**\$139**

PN: AH1230

100m Roll

**\$419**

PN: AH12100



## One-Touch Recoil Air Hoses



- One-Touch couplings
- Made from kink resistant polyurethane

10 MM Air Hoses

6.5 MM ID x 10 MM OD

2 Metre  
PN: GPH1003LBHL

**\$57**

5 Metre  
PN: GPH1006LBHL

**\$72**

6 Metre  
PN: GPH1008LBHL

**\$78**

8 Metre  
PN: GPH1010LBHL

**\$95**

12 MM Air Hoses

8 mm ID x 12 mm OD

5 Metre  
PN: GPH1206LBHL

**\$78**

6 Metre  
PN: GPH1208LBHL

**\$94**

8 Metre  
PN: GPH1210LBHL

**\$97**

10 Metre  
PN: GPH1212LBHL

**\$110**

## One-Touch Fitted Air Hoses



Fitted with Japanese compatible One-Touch couplings.

10 MM Fitted Air Hoses  
10 MM ID

10 Metre  
PN: AH1010F

**\$52**

20 Metre  
PN: AH1020F

**\$83**

30 Metre  
PN: AH1030F

**\$109**

12 MM Fitted Air Hoses  
12 mm ID

20 Metre  
PN: AH1220F

**\$119**

30 Metre  
PN: AH1230F

**\$159**



Made in Australia

# Impact Socket Sets

**HOT PRICES!**

Made from Chrome Molybdenum Steel CR-MO.

Meet or exceed DIN & ANSI standards.

## 3/8" Drive Impact Socket Sets

8 Piece Metric  
PN: GX838SSM

Sizes: 8, 10, 11, 12, 13, 15, 17 & 19 mm

8 Piece Imperial  
PN: GX838SSI

Sizes: 5/16", 3/8", 7/16", 1/2", 9/16", 5/8", 11/16" & 3/4"



was \$62 **Now! \$49 ea**

## 1/2" Drive Impact Socket Sets

13 Piece Metric  
PN: GX1312SSM

Sizes: 10, 12, 13, 14, 15, 17, 18, 19, 21, 22, 24, 27 & 30 mm

13 Piece Imperial  
PN: GX1312SSI

Sizes 7/16, 1/2, 9/16, 5/8, 11/16, 3/4, 13/16, 7/8, 15/16, 1, 1-1/16, 1-1/8 & 1-1/4"



was \$169 **Now! \$99 ea**

## 3/4" Drive Impact Socket Sets

8 Piece Metric  
PN: GX834SSM

Sizes: 26, 27, 29, 30, 32, 35, 36 & 38 mm

8 Piece Imperial  
PN: GX834SSI

Sizes 1, 1-1/16, 1-1/8, 1-1/4, 1-5/16, 1-3/8, 1-7/16 & 1-1/2"



was \$229 **Now! \$189 ea**

## Impact Hex & Torx® Bit Sets

Made from SNCM 8660 Steel which allows 20% more torque than CR-MO.

1/2" 8 Piece Metric Hex Bit Set  
PN: GX12HBSM

Sizes: H5, H6, H8, H10, H12, H14, H17 & H19 mm

1/2" 8 Piece Imperial Hex Bit Set  
PN: GX12HBSI

Sizes: 1/4", 5/16", 3/8", 7/16", 1/2", 9/16", 5/8" & 3/4"



was \$99 **Now! \$79 ea**

1/2" Torx® Impact Socket Set

Sizes: T25, T27, T30, T40, T45, T50, T55 & T60 bits

**\$99**  
PN: GX12TX8



## Impact Universal Joints

Molybdenum Steel CR-MO.



3/8" Drive Universal Joint

**\$28**  
PN: GX38U

1/2" Drive Universal Joint

**\$29**  
PN: GX12U

3/4" Drive Universal Joint

**\$57**  
PN: GX34U

## 5 Piece Square Drive Adapter Sets



Chrome Vanadium

1/4" Female to 3/8" Male  
1/2" Female to 3/8" Male  
3/8" Female to 1/4" Male  
1/2" Female to 3/4" Male  
3/8" Female to 1/2" Male

**\$29**  
PN: GXEAS

## Wobble Impacting Bar Sets



Chrome Molybdenum Steel CR-MO.

1/4" Set of 4 Wobble Extension Bars

Kit includes: 3", 6", 10" & 12" bars

**\$59**  
PN: GXWEBS14

1/2" Set of 4 Wobble Extension Bars

Kit includes: 3", 5", 10" & 18" bars

**\$99**  
PN: GXWEBS12

## Twin LED Rechargeable Inspection Lamp

Ideal for automotive panel & paint inspection or any confined automotive or industrial work environments.

- Precision adjustable dimmer switch
- Multistage battery indicator light
- Magnetic ball jointed adjustable base
- Dual retractable lamp hangers
- USB rechargeable Li-ion battery
- Magnetic retrieval wand at tip
- IP54 dust & water resistant



**\$159**  
PN: GLED2CIL

**SUPER BRIGHT 880 LUMENS!**

## Desktop Magnification Lamp

- Adjustable height & angle
- Interchangeable 100 mm lens (sold separately)
- Bright 560 Lumen LED lamp with lens cover

Lens dia.: 100 mm  
Magnification: 3 Diopter  
Max lens height: 300 mm  
Brightness: 560 Lumen  
Power supply: 240V  
Cord length: 1.3m

**560 LUMEN LED LAMP**



**\$99**  
PN: ML30

## Workbench Magnification Lamp

- Mountable to most workbenches up to 60 mm thick
- 900 mm Two piece articulated arm
- 60 LED lamp with high & low modes
- High quality metal frame construction.



**900MM REACH!**

**760 LUMENS**

Magnification: 3 Diopter  
Lens dia.: 120 mm  
Lamp: 60 x LED  
Power: 240 V

**\$199**  
PN: ML60

# The WORKSHOP Catalogue

March - June 2025  
All prices quoted include GST.

Distributed by:



## Economical Random Orbit Sanders

6" / 150 MM Random Orbit Sander

Free Speed: 12,000 RPM  
Orbit Dia.: 5 mm  
Weight: 830 g

**\$110**

PN: GP6151-6

6" / 150 MM Random Orbit Dust Free Sander

Free Speed: 12,000 RPM  
Orbit Dia.: 5 mm  
Weight: 930 g

**\$129**

PN: GP6151-6-S



## Economical 6" Backing Pads

Spindle Size: 5/16" x 24 UNF Ext.  
Max Speed: 12,000 RPM  
Pad Thickness: 10 mm

**\$20 ea**

Standard PN: E6505

Dust Free PN: E6565



**MICHAELPRO** Made in Taiwan.

## 3/4" Dr Extended Impact Sockets

• One-Piece Chrome Molybdenum Steel



• 200 MM Overall Length

6 POINT

32 mm Socket PN: MP005055 **\$139**

33 mm Socket PN: MP005056 **\$142**

41 mm Socket PN: MP005057 **\$146**

## morrisflex

## NG6 Burr Sets

3/8" Head NG6 Coated Burr Set



**\$249**

PN: CBSET3NG6C

1/2" Head NG6 Coated Burr Set



**\$379**

PN: CBSET35NG6C

1/4" & 3/8" Head NG6 Coated Burr Set



**\$419**

PN: CBSET8NG6C

**NG6** NEXT GENERATION ACCELERATOR

Full range on page 10.

# RED HOT RUNOUT SPECIALS

Only While Stocks Last!



## 1/2" Reversible Keyless Drill



Free speed: 800 RPM  
Weight: 1.95 Kg

**\$249**

PN: BDR208KLA1

## T-Nailers

Nail Length: 18-64 mm  
Capacity: 80 nails  
Weight: 2.55 Kg

2.2 mm Nail Shank PN: BT2264A1

2.5 mm Nail Shank PN: BT2564A1

**\$389 ea**



## 3/8" Heavy Duty Drill



Free Speed: 2300 RPM  
Chuck Cap.: 3/8"  
Weight: 0.83 Kg

**\$139**

PN: KP5302

## Heavy Duty Coil Nailer

Shank: 2.03-2.8 mm  
Nail Length: 32-65 mm  
Capacity: 200-400 nails  
Weight: 2.3 Kg

0° Angle PN: BC2865F1

15° Angle PN: BC2865D1

**\$489 ea**



## 34° DA Nailer



• Swivel exhaust  
• Depth adjustment  
• Angled air inlet

**\$369**

PN: BA3464A1

Shank: 1.8 mm (15 gauge)  
Nail Length: 25-64 mm  
Capacity: 100 Nails  
Weight: 1.95 Kg

## 3/4" Impact Wrench

Free Speed: 6,500 RPM  
Max Torque: 750 Ft/lbs  
Weight: 4.55 Kg



**\$599**

PN: KP1023

## 3/4" Impact Wrench with 6" Extension

Free Speed: 6,500 RPM  
Max Torque: 750 Ft/lbs  
Weight: 4.9 Kg



**\$659**

PN: KP1023-6